

ANNEX I
SUMMARY OF PRODUCT CHARACTERISTICS

1. NAME OF THE MEDICINAL PRODUCT

MIRCERA 30 micrograms/0.3 ml solution for injection in pre-filled syringe
MIRCERA 40 micrograms/0.3 ml solution for injection in pre-filled syringe
MIRCERA 50 micrograms/0.3 ml solution for injection in pre-filled syringe
MIRCERA 60 micrograms/0.3 ml solution for injection in pre-filled syringe
MIRCERA 75 micrograms/0.3 ml solution for injection in pre-filled syringe
MIRCERA 100 micrograms/0.3 ml solution for injection in pre-filled syringe
MIRCERA 120 micrograms/0.3 ml solution for injection in pre-filled syringe
MIRCERA 150 micrograms/0.3 ml solution for injection in pre-filled syringe
MIRCERA 200 micrograms/0.3 ml solution for injection in pre-filled syringe
MIRCERA 250 micrograms/0.3 ml solution for injection in pre-filled syringe
MIRCERA 360 micrograms/0.6 ml solution for injection in pre-filled syringe

2. QUALITATIVE AND QUANTITATIVE COMPOSITION

MIRCERA 30 micrograms/0.3 ml solution for injection in pre-filled syringe

One pre-filled syringe contains 30 micrograms of methoxy polyethylene glycol-epoetin beta* at a concentration of 100 micrograms/ml

MIRCERA 40 micrograms/0.3 ml solution for injection in pre-filled syringe

One pre-filled syringe contains 40 micrograms of methoxy polyethylene glycol-epoetin beta* at a concentration of 133 micrograms/ml.

MIRCERA 50 micrograms/0.3 ml solution for injection in pre-filled syringe

One pre-filled syringe contains 50 micrograms of methoxy polyethylene glycol-epoetin beta* at a concentration of 167 micrograms/ml.

MIRCERA 60 micrograms/0.3 ml solution for injection in pre-filled syringe

One pre-filled syringe contains 60 micrograms of methoxy polyethylene glycol-epoetin beta* at a concentration of 200 micrograms/ml.

MIRCERA 75 micrograms/0.3 ml solution for injection in pre-filled syringe

One pre-filled syringe contains 75 micrograms of methoxy polyethylene glycol-epoetin beta* at a concentration of 250 micrograms/ml

MIRCERA 100 micrograms/0.3 ml solution for injection in pre-filled syringe

One pre-filled syringe contains 100 micrograms of methoxy polyethylene glycol-epoetin beta* at a concentration of 333 micrograms/ml.

MIRCERA 120 micrograms/0.3 ml solution for injection in pre-filled syringe

One pre-filled syringe contains 120 micrograms of methoxy polyethylene glycol-epoetin beta* at a concentration of 400 micrograms/ml.

MIRCERA 150 micrograms/0.3 ml solution for injection in pre-filled syringe

One pre-filled syringe contains 150 micrograms of methoxy polyethylene glycol-epoetin beta* at a concentration of 500 micrograms/ml.

MIRCERA 200 micrograms/0.3 ml solution for injection in pre-filled syringe

One pre-filled syringe contains 200 micrograms of methoxy polyethylene glycol-epoetin beta* at a concentration of 667 micrograms/ml

MIRCERA 250 micrograms/0.3 ml solution for injection in pre-filled syringe

One pre-filled syringe contains 250 micrograms of methoxy polyethylene glycol-epoetin beta* at a concentration of 833 micrograms/ml.

MIRCERA 360 micrograms/0.6 ml solution for injection in pre-filled syringe

One pre-filled syringe contains 360 micrograms of methoxy polyethylene glycol-epoetin beta* at a concentration of 600 micrograms/ml.

The strength indicates the quantity of the protein moiety of the methoxy polyethylene glycol-epoetin beta molecule without consideration of the glycosylation.

*Protein produced by recombinant DNA technology in Chinese Hamster Ovary (CHO) cells and covalently conjugated to a linear methoxy-polyethylene glycol (PEG).

The potency of methoxy polyethene glycol-epoetin beta should not be compared to the potency of another pegylated or non-pegylated protein of the same therapeutic class. For more information, see section 5.1.

For the full list of excipients, see section 6.1.

3. PHARMACEUTICAL FORM

Solution for injection in pre-filled syringe (injection).
The solution is clear and colourless to slightly yellowish.

4. CLINICAL PARTICULARS

4.1 Therapeutic indications

Treatment of symptomatic anaemia associated with chronic kidney disease (CKD) in adult patients (see section 5.1).

Treatment of symptomatic anaemia associated with chronic kidney disease (CKD) in paediatric patients from 3 months to less than 18 years of age who are converting from another erythropoiesis stimulating agent (ESA) after their haemoglobin level was stabilised with the previous ESA (see section 5.1).

4.2 Posology and method of administration.

Treatment has to be initiated under the supervision of a physician experienced in the management of patients with renal impairment.

Posology

Treatment of symptomatic anaemia in chronic kidney disease patients

Anaemia symptoms and sequelae may vary with age, gender, and overall burden of disease; a physician's evaluation of the individual patient's clinical course and condition is necessary. Treatment should be administered either subcutaneously or intravenously in order to increase haemoglobin to not greater than 12 g/dl (7.45 mmol/l). Subcutaneous use is preferable in patients who are not receiving haemodialysis to avoid puncture of peripheral veins.

Due to intra-patient variability, occasional individual haemoglobin values for a patient above and below the desired haemoglobin level may be observed. Haemoglobin variability should be addressed through dose management, with consideration for the haemoglobin target range of 10 g/dl (6.21 mmol/l) to 12 g/dl (7.45 mmol/l). A sustained haemoglobin level of greater than 12 g/dl (7.45 mmol/l) should be avoided; guidance for appropriate dose adjustment for when haemoglobin values exceeding 12 g/dl (7.45 mmol/l) are observed are described below.

A rise in haemoglobin of greater than 2 g/dl (1.24 mmol/l) in adult patients and 1 g/dl (0.62 mmol/l) in paediatric patients over a four-week period should be avoided. If it occurs, appropriate dose adjustment should be made as provided.

Patients should be monitored closely to ensure that the lowest approved effective dose of treatment is used to provide adequate control of the symptoms of anaemia whilst maintaining a haemoglobin concentration below or at 12 g/dl (7.45 mmol/l).

Caution should be exercised with escalation of treatment doses in patients with chronic renal failure. In patients with a poor haemoglobin response to treatment, alternative explanations for the poor response should be considered (see section 4.4 and 5.1).

It is recommended that haemoglobin is monitored every two weeks until stabilised and periodically thereafter (see section 4.4).

Adult patients not currently treated with an erythropoiesis stimulating agent (ESA):

In order to increase haemoglobin levels to greater than 10 g/dl (6.21 mmol/l), the recommended starting dose in patients not on dialysis is 1.2 microgram/kg body weight, administered once every month as a single subcutaneous injection.

Alternatively, a starting dose of 0.6 microgram/kg bodyweight may be administered once every two weeks as a single intravenous or subcutaneous injection in patients on dialysis or not on dialysis.

The dose may be increased by approximately 25% of the previous dose if the rate of rise in haemoglobin is less than 1.0 g/dl (0.621 mmol/l) over a month. Further increases of approximately 25% may be made at monthly intervals until the individual target haemoglobin level is obtained.

If the rate of rise in haemoglobin is greater than 2 g/dl (1.24 mmol/l) in one month or if the haemoglobin level is increasing and approaching 12 g/dl (7.45 mmol/l), the dose is to be reduced by approximately 25%. If the haemoglobin level continues to increase, therapy should be interrupted until the haemoglobin level begins to decrease, at which point therapy should be restarted at a dose approximately 25% below the previously administered dose. After dose interruption a haemoglobin decrease of approximately 0.35 g/dl (0.22 mmol/l) per week is expected. Dose adjustments should not be made more frequently than once a month.

Patients treated once every two weeks whose haemoglobin concentration is above 10 g/dl (6.21 mmol/l) may receive methoxy polyethylene glycol-epoetin beta administered once-monthly using the dose equal to twice the previous once-every-two-week dose.

Adult patients currently treated with an ESA:

Patients currently treated with an ESA can be switched to methoxy polyethylene glycol-epoetin beta administered once a month as a single intravenous or subcutaneous injection. The starting dose of methoxy polyethylene glycol-epoetin beta is based on the calculated previous weekly dose of darbepoetin alfa or epoetin at the time of substitution as described in Table 1. The first injection should start at the next scheduled dose of the previously administered darbepoetin alfa or epoetin.

Table 1: Methoxy polyethylene glycol-epoetin beta starting doses for adult patients currently receiving an ESA

Previous weekly darbepoetin alfa intravenous or subcutaneous dose (microgram/week)	Previous weekly epoetin intravenous or subcutaneous dose (IU/week)	Monthly methoxy polyethylene glycol-epoetin beta intravenous or subcutaneous dose (microgram/once monthly)
<40	<8000	120
40-80	8000-16000	200
>80	>16000	360

If a dose adjustment is required to maintain the target haemoglobin concentration above 10 g/dl (6.21 mmol/l), the monthly dose may be increased by approximately 25%.

If the rate of rise in haemoglobin is greater than 2 g/dl (1.24 mmol/l) over a month or if the haemoglobin level is increasing and approaching 12 g/dl (7.45 mmol/l), the dose is to be reduced by

approximately 25%. If the haemoglobin level continues to increase, therapy should be interrupted until the haemoglobin level begins to decrease, at which point therapy should be restarted at a dose approximately 25% below the previously administered dose. After dose interruption a haemoglobin decrease of approximately 0.35 g/dl (0.22 mmol/l) per week is expected. Dose adjustments should not be made more frequently than once a month.

Since the treatment experience is limited in patients on peritoneal dialysis, regular haemoglobin monitoring and strict adherence to dose adjustment guidance are recommended in these patients.

Paediatric patients from 3 months to less than 18 years of age currently treated with an ESA:

Paediatric patients whose haemoglobin level has been stabilised by treatment with an ESA can be converted to methoxy polyethylene glycol-epoetin beta administered once every 4 weeks as an IV or SC injection, but keeping the same administration route. The starting dose of methoxy polyethylene glycol-epoetin beta is calculated based on the total weekly ESA dose at the time of conversion (Table 2).

Table 2. Methoxy polyethylene glycol-epoetin beta starting doses for paediatric patients from 3 months to less than 18 years of age currently receiving an ESA

Previous weekly darbepoetin alfa dose (microgram/week)	Previous weekly epoetin dose (IU/week)	Every 4-week methoxy polyethylene glycol-epoetin beta dose (microgram)
9 - <12	2000 - <2700	30
12 - <15	2700 - <3500	50
15 - <24	3500 - <5500	75
24 - <30	5500 - <6500	100
30 - <35	6500 - <8000	120
35 - <47	8000 - <10000	150
47 - <60	10000 - <13000	200
60 - <90	13000 - <20000	250
≥90	≥20000	360

Pre-filled syringes are not designed for administration of partial doses. Due to the available dose strengths of pre-filled syringes, paediatric patients with an ESA dose of <9 microgram/week (darbepoetin alfa) or <2000 IU/week of epoetin, should not be switched to methoxy polyethylene glycol-epoetin beta.

If a dose adjustment is required to maintain the target haemoglobin concentration above 10 g/dl, the 4 weekly dose may be adjusted by approximately 25%.

If the rise in haemoglobin is greater than 1 g/dl (0.62 mmol/l) over 4 weeks or the haemoglobin level is increasing and approaching 12 g/dl (7.45 mmol/l), the methoxy polyethylene glycol-epoetin beta dose is to be reduced by approximately 25%.

If the haemoglobin level continues to increase following dose reduction, therapy is to be interrupted until the haemoglobin level begins to decrease, at which point therapy should be restarted at a dose approximately 25% below the previously administered dose.

Dose adjustments should not be made more often than once every 4 weeks.

Treatment interruption

Treatment is normally long-term. However, it can be interrupted at any time, if necessary.

Missed dose

If one dose of treatment is missed, the missed dose is to be administered as soon as possible and administration of treatment is to be restarted at the prescribed dosing frequency.

Paediatric population

The safety and efficacy of methoxy polyethylene glycol-epoetin beta in paediatric patients less than 3 months of age have not been established. No data are available.

Special populations

Patients with hepatic impairment

No adjustments of the starting dose nor of the dose modification rules are required in patients with hepatic impairment (see section 5.2).

Elderly population

In clinical studies 24% of patients treated with methoxy polyethylene glycol-epoetin beta were aged 65 to 74 years, while 20% were aged 75 years and over. No dose adjustment is required in patients aged 65 years or older.

Method of administration

Treatment should be administered either subcutaneously or intravenously. It can be injected subcutaneously in the abdomen, arm or thigh. All three injection sites are equally suitable. For instructions on the administration of the medicinal product, see section 6.6.

4.3 Contraindications

Hypersensitivity to the active substance or to any of the excipients listed in section 6.1.
Uncontrolled hypertension.

4.4 Special warnings and precautions for use

The safety and efficacy of methoxy polyethylene glycol-epoetin beta therapy in other indications, including anaemia in patients with cancer, has not been established.

Caution should be exercised with escalation of methoxy polyethylene glycol-epoetin beta doses in patients with chronic renal failure since high cumulative epoetin doses may be associated with an increased risk of mortality, serious cardiovascular and cerebrovascular events. In patients with a poor haemoglobin response to epoetins, alternative explanations for the poor response should be considered (see section 4.2 and 5.1).

Paediatric population:

Paediatric patients, especially children <1 year of age, should be carefully evaluated before switching from another ESA treatment and the haemoglobin level should be stabilised prior to switching. Following ESA conversion, it is recommended that haemoglobin is monitored every 4 weeks.

If the current ESA dose is <9 microgram/week of darbepoetin alfa or <2000 IU/week of epoetin, the patient should not be switched to methoxy polyethylene glycol-epoetin beta, as the lowest available pre-filled syringe dose strength is 30 micrograms. Administration of partial doses with pre-filled syringes is not recommended.

Supplementary iron therapy is recommended for all patients with serum ferritin values below 100 microgram/l or with transferrin saturation below 20%. To ensure effective erythropoiesis, iron status has to be evaluated for all patients prior to and during treatment.

Failure to respond to treatment should prompt for a search for causative factors. Deficiencies of iron, folic acid or vitamin B12 reduce the effectiveness of ESAs and should therefore be corrected. Intercurrent infections, inflammatory or traumatic episodes, occult blood loss, haemolysis, severe

aluminium toxicity, underlying haematologic diseases, or bone marrow fibrosis may also compromise the erythropoietic response. A reticulocyte count should be considered as part of the evaluation. If all the conditions mentioned are excluded and the patient has a sudden drop of haemoglobin associated with reticulocytopenia and anti-erythropoietin antibodies, examination of the bone marrow for the diagnosis of Pure Red Cell Aplasia (PRCA) should be considered. In case PRCA is diagnosed, treatment must be discontinued and patients should not be switched to another ESA.

Physicians may request the Marketing Authorisation Holder to test or re-test serum samples in a reference laboratory for cases of suspected or confirmed AEAB-mediated PRCA or unexplained loss of effect under treatment (e.g. observed clinically by severe anaemia and low reticulocyte count).

Pure Red Cell Aplasia caused by anti-erythropoietin antibodies has been reported in association with all ESAs, including methoxy polyethylene glycol-epoetin beta. These antibodies have been shown to cross-react with all ESAs, and patients suspected or confirmed to have antibodies to erythropoietin should not be switched to methoxy polyethylene glycol-epoetin beta (see section 4.8).

PRCA in patients with Hepatitis C: A paradoxical decrease in haemoglobin and development of severe anaemia associated with low reticulocyte counts should prompt to discontinue treatment with epoetin and perform anti-erythropoietin antibody testing. Cases have been reported in patients with hepatitis C treated with interferon and ribavirin, when epoetins are used concomitantly. Epoetins are not approved in the management of anaemia associated with hepatitis C.

Blood pressure monitoring: As with other ESAs, blood pressure may rise during treatment with methoxy polyethylene glycol-epoetin beta. Blood pressure should be adequately controlled in all patients before, at initiation of, and during treatment with methoxy polyethylene glycol-epoetin beta. If high blood pressure is difficult to control by medical treatment or dietary measures, the dose must be reduced or administration discontinued (see section 4.2).

Severe cutaneous adverse reactions (SCARs) including Stevens-Johnson syndrome (SJS) and toxic epidermal necrolysis (TEN), which can be life-threatening or fatal, have been reported in association with epoetin treatment (see section 4.8). More severe cases have been observed with long-acting epoetins. At the time of prescription patients should be advised of the signs and symptoms and monitored closely for skin reactions. If signs and symptoms suggestive of these reactions appear, methoxy polyethylene glycol-epoetin beta should be withdrawn immediately and an alternative treatment considered. If the patient has developed a severe cutaneous skin reaction such as SJS or TEN due to the use of methoxy polyethylene glycol-epoetin beta, treatment with ESA must not be restarted in this patient at any time.

Haemoglobin concentration: In patients with chronic kidney disease, maintenance haemoglobin concentration should not exceed the upper limit of the target haemoglobin concentration recommended in section 4.2. In clinical trials, an increased risk of death, serious cardiovascular events including thrombosis or cerebrovascular events including stroke was observed when ESAs were administered to target a haemoglobin of greater than 12 g/dl (7.5 mmol/l) (see section 4.8). Controlled clinical trials have not shown significant benefits attributable to the administration of epoetins when haemoglobin concentration is increased beyond the level necessary to control symptoms of anaemia and to avoid blood transfusion.

The safety and efficacy of treatment has not been established in patients with haemoglobinopathies, seizures, bleeding or a recent history of bleeding requiring transfusions or with platelet levels greater than $500 \times 10^9/l$. Therefore, caution should be used in these patients.

Effect on tumour growth: Methoxy polyethylene glycol-epoetin beta, like other ESAs, is a growth factor that primarily stimulates red blood cell production. Erythropoietin receptors may be expressed on the surface of a variety of tumour cells. As with all growth factors, there is a concern that ESAs could stimulate the growth of any type of malignancy. Two controlled clinical studies in which epoetins were administered to patients with various cancers including head and neck cancers, and breast cancer, have shown an unexplained excess mortality.

Misuse of methoxy polyethylene glycol-epoetin beta by healthy people may lead to an excessive increase in haemoglobin. This may be associated with life-threatening cardiovascular complications.

Traceability: In order to improve the traceability of biological medicinal products, the name and the batch number of the administered product should be clearly recorded.

This medicinal product contains less than 1 mmol sodium (23 mg) per ml, that is to say essentially 'sodium free'.

4.5 Interaction with other medicinal products and other forms of interaction

No interaction studies have been performed. There is no evidence that methoxy polyethylene glycol-epoetin beta alters the metabolism of other medicinal products.

4.6 Fertility, pregnancy and lactation

Pregnancy

There are no data from the use of methoxy polyethylene glycol-epoetin beta in pregnant women. Animal studies do not indicate direct harmful effects with respect to pregnancy, embryofetal development, parturition or postnatal development but indicate a class-related reversible reduction in foetal weight (see section 5.3). Caution should be exercised when prescribing to pregnant women.

Breast-feeding

It is unknown whether methoxy polyethylene glycol-epoetin beta is excreted in human breast milk. One animal study has shown excretion of methoxy polyethylene glycol-epoetin beta in maternal milk. A decision on whether to continue or discontinue breast-feeding or to continue or discontinue therapy with methoxy polyethylene glycol-epoetin beta should be made taking into account the benefit of breast-feeding to the child and the benefit of methoxy polyethylene glycol-epoetin beta therapy to the woman.

Fertility

Studies in animals have shown no evidence of impaired fertility (see section 5.3). The potential risk for humans is unknown.

4.7 Effects on ability to drive and use machines

Methoxy polyethylene glycol-epoetin beta has no or negligible influence on the ability to drive and use machines.

4.8 Undesirable effects

(a) Summary of the safety profile

The safety data base from clinical trials comprised 3,042 CKD adult patients, including 1,939 adult patients treated with methoxy polyethylene glycol-epoetin beta and 1,103 with another ESA. Approximately 6% of adult patients treated with methoxy polyethylene glycol-epoetin beta are expected to experience adverse reactions. The most frequent reported adverse reaction was hypertension (common).

(b) Tabulated list of adverse reactions

Adverse reactions in Table 3 are listed according to MedDRA system organ class and frequency category. Frequency categories are defined using the following convention: very common ($\geq 1/10$); common ($\geq 1/100$ to $< 1/10$); uncommon ($\geq 1/1,000$ to $< 1/100$); rare ($\geq 1/10,000$ to $< 1/1,000$); very rare ($< 1/10,000$); not known (cannot be estimated from the available data).

Table 3: Adverse reactions attributed to the treatment with methoxy polyethylene glycol-epoetin beta in CKD adult patients. Adverse reactions observed only during post-marketing are marked (*).

System organ class	Frequency	Adverse reaction
Blood and lymphatic system disorders	Uncommon	Thrombocytopenia*
	Not known	Pure red cell aplasia*
Immune system disorders	Rare	Hypersensitivity
	Not known	Anaphylactic reaction*
Nervous system disorders	Uncommon	Headache
	Rare	Hypertensive encephalopathy
Vascular disorders	Common	Hypertension
	Uncommon	Thrombosis*
	Rare	Hot flush
	Rare	Pulmonary embolism*
Skin and subcutaneous disorders	Rare	Rash, maculopapular
	Not known	Stevens-Johnson syndrome / toxic epidermal necrolysis*
Injury, poisoning and procedural complications	Uncommon	Vascular access site thrombosis

(c) Description of selected adverse reactions

Adult population

Cases of thrombocytopenia have been reported from post-marketing setting. A slight decrease in platelet counts remaining within the normal range was observed in clinical studies. Platelet counts below $100 \times 10^9/l$ were observed in 7% of adult patients treated with methoxy polyethylene glycol-epoetin beta and 4% of adult patients treated with other ESAs during clinical development. In a post-authorisation safety study with long treatment exposure of up to 8.4 years, baseline platelet counts below $100 \times 10^9/l$ was present in 2.1% of adult patients in the methoxy polyethylene glycol-epoetin beta group and 2.4% of adult patients in other ESAs group. During the study, platelet counts below $100 \times 10^9/l$ were observed yearly in 1.5% to 3.0% of adult patients treated with methoxy polyethylene glycol-epoetin beta and 1.6% to 2.5% of adult patients treated with other ESAs.

Data from a controlled clinical trial with epoetin alfa or darbepoetin alfa reported an incidence of stroke as common. A post-authorisation safety study showed similar incidence of stroke between methoxy polyethylene glycol-epoetin beta (6.3%) and reference ESAs groups (epoetin alfa, darbepoetin alfa and epoetin beta) (7%).

As with other ESAs, cases of thrombosis, including pulmonary embolism, have been reported in the post-marketing setting (see section 4.4).

Neutralising anti-erythropoietin antibody-mediated pure red cell aplasia (PRCA) has been reported, frequency unknown. In case PRCA is diagnosed, therapy with methoxy polyethylene glycol-epoetin beta must be discontinued, and patients should not be switched to another recombinant erythropoietic protein (see section 4.4).

Paediatric population

In the two paediatric studies, the paediatric population studied comprised a total of 104 patients, of which 12 were less than 5 years of age, 36 were 5 to 11 years of age and 56 were 12 to 17 years of age. The safety profile of methoxy polyethylene glycol-epoetin beta in the paediatric population included in these two studies was overall consistent with that known for the adult population, based on low patient exposure in these studies (see section 5.1).

Reporting of suspected adverse reactions

Reporting suspected adverse reactions after authorisation of the medicinal product is important. It allows continued monitoring of the benefit/risk balance of the medicinal product. Healthcare professionals are asked to report any suspected adverse reactions via the national reporting system listed in Appendix V.

4.9 Overdose

The therapeutic range of methoxy polyethylene glycol-epoetin beta is wide. Individual responsiveness must be considered when treatment is initiated. Overdose can result in manifestations of an exaggerated pharmacodynamic effect, e.g. excessive erythropoiesis. In case of excessive haemoglobin levels, treatment with methoxy polyethylene glycol-epoetin beta should be temporarily discontinued (see section 4.2). If clinically indicated, phlebotomy may be performed.

5. PHARMACOLOGICAL PROPERTIES

5.1 Pharmacodynamic properties

Pharmacotherapeutic group: Other antianemic preparations, ATC code: B03XA03

Mechanism of action

Methoxy polyethylene glycol-epoetin beta stimulates erythropoiesis by interaction with the erythropoietin receptor on progenitor cells in the bone marrow. Methoxy polyethylene glycol-epoetin beta, the active substance of MIRCERA, is a continuous erythropoietin receptor activator that shows a different activity at the receptor level characterized by a slower association to and faster dissociation from the receptor, a reduced specific activity *in vitro* with an increased activity *in vivo*, as well as an increased half-life, in contrast to erythropoietin. The average molecular mass is approximately 60 kDa of which the protein moiety plus the carbohydrate part constitutes approximately 30 kDa.

Pharmacodynamic effects

As primary growth factor for erythroid development, the natural hormone erythropoietin is produced in the kidney and released into the bloodstream in response to hypoxia. In responding to hypoxia, the natural hormone erythropoietin interacts with erythroid progenitor cells to increase red cell production.

Clinical efficacy and safety

Adult population

Data from correction studies with patients treated once every two weeks and once every four weeks show that the haemoglobin response rates in the methoxy polyethylene glycol-epoetin beta group at the end of the correction period were high and comparable to comparators. The median time to response was 43 days in the methoxy polyethylene glycol-epoetin beta arm and 29 days in the comparator arm, with increases of haemoglobin within the first 6 weeks of 0.2 g/dl/week and 0.3 g/dl/week, respectively.

Four randomized controlled studies were performed in dialysis patients currently treated with darbepoetin alfa or epoetin at the time of enrollment. Patients were randomized to stay on their treatment at the time of enrollment or to be switched to methoxy polyethylene glycol-epoetin beta in order to maintain stable haemoglobin levels. At the evaluation period (week 29-36), the mean and median level of haemoglobin in patients treated with methoxy polyethylene glycol-epoetin beta was virtually identical to their baseline haemoglobin level.

In a randomised, double-blind, placebo-controlled study of 4,038 CRF patients not on dialysis with type 2 diabetes and haemoglobin levels ≤ 11 g/dl, patients received either treatment with darbepoetin alfa to target haemoglobin levels of 13 g/dl or placebo (see section 4.4). The study did not meet either primary objective of demonstrating a reduction in risk for all-cause mortality, cardiovascular

morbidity, or end stage renal disease (ESRD). Analysis of the individual components of the composite endpoints showed the following HR (95% CI): death 1.05 (0.92, 1.21), stroke 1.92 (1.38, 2.68), congestive heart failure (CHF) 0.89 (0.74, 1.08), myocardial infarction (MI) 0.96 (0.75, 1.23), hospitalisation for myocardial ischaemia 0.84 (0.55, 1.27), ESRD 1.02 (0.87, 1.18).

Pooled post-hoc analyses of clinical studies of ESAs have been performed in chronic renal failure patients (on dialysis, not on dialysis, in diabetic and non-diabetic patients). A tendency towards increased risk estimates for all-cause mortality, cardiovascular and cerebrovascular events associated with higher cumulative ESA doses independent of the diabetes or dialysis status was observed (see section 4.2 and section 4.4).

Erythropoietin is a growth factor that primarily stimulates red cell production. Erythropoietin receptors may be expressed on the surface of a variety of tumour cells.

Survival and tumour progression have been examined in five large controlled studies involving a total of 2,833 patients, of which four were double-blind placebo-controlled studies and one was an open-label study. Two of the studies recruited patients who were being treated with chemotherapy. The target haemoglobin concentration in two studies was >13 g/dl; in the remaining three studies it was 12-14 g/dl. In the open-label study there was no difference in overall survival between patients treated with recombinant human erythropoietin and controls. In the four placebo-controlled studies the hazard ratios for overall survival ranged between 1.25 and 2.47 in favour of controls. These studies have shown a consistent unexplained statistically significant excess mortality in patients who have anaemia associated with various common cancers who received recombinant human erythropoietin compared to controls. Overall survival outcome in the trials could not be satisfactorily explained by differences in the incidence of thrombosis and related complications between those given recombinant human erythropoietin and those in the control group.

A patient-level data analysis has also been performed on more than 13,900 cancer patients (chemo-, radio-, chemoradio-, or no therapy) participating in 53 controlled clinical trials involving several epoetins. Meta-analysis of overall survival data produced a hazard ratio point estimate of 1.06 in favour of controls (95% CI: 1.00, 1.12; 53 trials and 13,933 patients) and for the cancer patients receiving chemotherapy, the overall survival hazard ratio was 1.04 (95% CI: 0.97, 1.11; 38 trials and 10,441 patients). Meta-analyses also indicate consistently a significantly increased relative risk of thromboembolic events in cancer patients receiving recombinant human erythropoietin (see section 4.4). No patients treated with methoxy polyethylene glycol-epoetin beta were included in this data analysis.

Methoxy polyethylene glycol-epoetin beta is not approved for treatment of patients with chemotherapy induced anaemia (see section 4.1 and 4.4.).

Paediatric population

Two studies have been conducted in paediatric patients. One study with intravenous administration (IV) and one study with subcutaneous administration (SC) of methoxy polyethylene glycol-epoetin beta.

The study using IV administration was a phase II, dose-finding, open-label, single-arm, multicenter, multiple dose study (NH19707) conducted in 64 paediatric patients (aged 5 to 17 years old) with CKD on hemodialysis, to evaluate two conversion factors (group 1 and group 2) in order to switch from maintenance treatment with IV epoetin alfa/beta or darbepoetin alfa to methoxy polyethylene glycol-epoetin beta, administered IV once every 4 weeks for 20 weeks. Efficacy was assessed based on the change in haemoglobin concentration (g/dl) between the baseline and evaluation period. The adjusted mean change in haemoglobin from baseline to the evaluation period in group 1 was -0.74 g/dl [95% CI: -1.32 to -0.16] and in group 2 it was -0.09 g/dl [95% CI: -0.45 to 0.26]. 58% and 75% of patients maintained haemoglobin values within ± 1 g/dl of baseline and 75% and 81% maintained haemoglobin values within 10-12 g/dl in group 1 and group 2 respectively. Subgroup analyses by age groups (5-11 years and 12-17 years) were consistent with the observations in the overall population. Patients who

completed the 20 weeks of core treatment, who adequately maintained haemoglobin levels were eligible to enter an optional 52-week safety extension period with the same dosing frequency.

The study using SC administration was a second phase II, dose-finding, open-label, single-arm, multicenter study (NH19708) conducted in 40 paediatric patients (aged 3 months to 17 years old) with CKD on dialysis, or not yet on dialysis, to evaluate the conversion factor used in group 2 in the IV study, in order to switch from maintenance treatment with SC epoetin alfa/ beta or darbopoetin alfa to methoxy polyethylene glycol-epoetin beta, administered SC once every 4 weeks for 20 weeks. Similarly, in this study, the primary efficacy endpoint was the change in haemoglobin concentration (g/dl) between the baseline and evaluation period. The mean change in haemoglobin concentration during the evaluation period was 0.48 g/dl [95% CI: 0.15 to 0.82], which was within the equivalence bounds of -1 to +1g/dl. The results of the mean change in haemoglobin concentration by age group (<5 years, 5-11 years, ≥12 years) were consistent with the results of the primary endpoint during the evaluation period. Patients who completed the 20 weeks of core treatment, who adequately maintained haemoglobin levels, were eligible to enter an optional 24-week safety extension period with the same dosing frequency.

In both the studies, the mean haemoglobin values remained within 10 to 12 g/dl throughout the entire evaluation period and safety extension period for the majority of patients. The safety profile observed in paediatric patients from both studies was consistent with that found in adults (see section 4.8).

5.2 Pharmacokinetic properties

Adult population

The pharmacokinetics of methoxy polyethylene glycol-epoetin beta were studied in healthy volunteers and in anaemic patients with CKD including patients on dialysis and not on dialysis.

Following subcutaneous administration to CKD patients not on dialysis, the maximum serum concentrations of methoxy polyethylene glycol-epoetin beta were observed 95 hours (median value) after administration. The absolute bioavailability of methoxy polyethylene glycol-epoetin beta after subcutaneous administration was 54%. The observed terminal elimination half-life was 142 hours in CKD patients not on dialysis.

Following subcutaneous administration to CKD patients on dialysis, the maximum serum concentrations of methoxy polyethylene glycol-epoetin beta were observed 72 hours (median value) after administration. The absolute bioavailability of methoxy polyethylene glycol-epoetin beta after subcutaneous administration was 62% and the observed terminal elimination half-life was 139 hours in CKD patients on dialysis.

Following intravenous administration to CKD patients on dialysis, the total systemic clearance was 0.494 ml/h per kg. The elimination half-life after intravenous administration of methoxy polyethylene glycol-epoetin beta is 134 hours.

A comparison of serum concentrations of methoxy polyethylene glycol-epoetin beta measured before and after haemodialysis in 41 CKD patients showed that haemodialysis has no effect on the pharmacokinetics of this medicinal product.

An analysis in 126 CKD patients showed no pharmacokinetic difference between patients on dialysis and patients not on dialysis.

In a single dose study, after intravenous administration, the pharmacokinetics of methoxy polyethylene glycol-epoetin beta are similar in patients with severe hepatic impairment as compared to healthy subjects (see section 4.2).

Paediatric population

A population pharmacokinetic analysis was performed with data from 103 paediatric patients, aged from 6 months to 17 years, body weight ranging from 7 to 90 kg, and 524 adult patients. Paediatric patients received methoxy polyethylene glycol-epoetin beta IV (all on hemodialysis) or SC (on peritoneal dialysis, hemodialysis or not yet on dialysis). Clearance and volume of distribution were found to increase with body weight and volume of distribution with age. The observed maximum and minimum serum concentrations of methoxy polyethylene glycol-epoetin beta in paediatric patients, collected when their haemoglobin levels were stabilised, were comparable to those observed in adults for both routes of administration, IV and SC.

5.3 Preclinical safety data

Non-clinical data show no special hazard for humans based on conventional studies of cardiovascular safety pharmacology, repeat dose toxicity and reproductive toxicity.

The carcinogenic potential of methoxy polyethylene glycol-epoetin beta has not been evaluated in long-term animal studies. It did not induce a proliferative response in non-haematological tumor cell lines *in vitro*. In a six-month rat toxicity study no tumorigenic or unexpected mitogenic responses were observed in non-haematological tissues. In addition, using a panel of human tissues, the *in vitro* binding of methoxy polyethylene glycol-epoetin beta was only observed in target cells (bone marrow progenitor cells).

No significant placental transfer of methoxy polyethylene glycol-epoetin beta was observed in the rat, and studies in animals have not shown any harmful effect on pregnancy, embryofetal development, parturition or postnatal development. There was however a class-related reversible reduction in foetal weight and a decrease in postnatal body-weight gain of offspring at the doses causing exaggerated pharmacodynamic effects in mothers. Physical, cognitive, or sexual developments in the offspring of mothers receiving methoxy polyethylene glycol-epoetin beta during gestation and lactation were not affected. When methoxy polyethylene glycol-epoetin beta was administered subcutaneously to male and female rats prior to and during mating, reproductive performance, fertility, and sperm assessment parameters were not affected.

6. PHARMACEUTICAL PARTICULARS

6.1 List of excipients

Sodium dihydrogen phosphate monohydrate
Sodium sulphate
Mannitol (E421)
Methionine
Poloxamer 188
Water for injections

6.2 Incompatibilities

In the absence of compatibility studies, this medicinal product must not be mixed with other medicinal products.

6.3 Shelf life

3 years

6.4 Special precautions for storage

Store in a refrigerator (2°C – 8°C).

Do not freeze.

Keep the pre-filled syringe in the outer carton in order to protect from light.

The end-user may remove the medicinal product from refrigeration for storage at a room temperature not above 30°C for one single period of 1 month. Once removed from the refrigerator the medicinal product must be used within this period.

6.5 Nature and contents of container

Pre-filled syringe (type I glass) with laminated plunger stopper (bromobutyl rubber) and tip cap (bromobutyl rubber) and a needle 27G1/2.

Pre-filled syringes 30, 40, 50, 60, 75, 100, 120, 150, 200 and 250 micrograms contain 0.3 ml solution. Pre-filled syringe 360 micrograms contains 0.6 ml solution.

Pre-filled syringes 30, 50, 75 micrograms are available in pack size of 1 or 3 pre-filled syringe(s).

Pre-filled syringes 40, 60, 100, 120, 150, 200, 250 and 360 micrograms are available in pack size of 1 pre-filled syringe.

Not all pack sizes may be marketed.

6.6 Special precautions for disposal and other handling

The pre-filled syringe is ready for use. The sterile pre-filled syringe does not contain any preservative and is to be used for a single injection only. Only one dose should be administered per syringe. Pre-filled syringes are not designed for administration of partial doses. Only solutions which are clear, colourless to slightly yellowish and free of visible particles must be injected.

Do not shake.

Allow the pre-filled syringe to reach room temperature before injecting.

Any unused medicinal product or waste material should be disposed of in accordance with local requirements.

7. MARKETING AUTHORISATION HOLDER

Roche Registration GmbH
Emil-Barell-Strasse 1
79639 Grenzach-Wyhlen
Germany

8. MARKETING AUTHORISATION NUMBER(S)

EU/1/07/400/008
EU/1/07/400/009
EU/1/07/400/010
EU/1/07/400/011
EU/1/07/400/012
EU/1/07/400/013
EU/1/07/400/017
EU/1/07/400/018
EU/1/07/400/019
EU/1/07/400/020
EU/1/07/400/021
EU/1/07/400/022
EU/1/07/400/023
EU/1/07/400/024

9. DATE OF FIRST AUTHORISATION/RENEWAL OF THE AUTHORISATION

Date of first authorisation: 20 July 2007

Date of latest renewal: 15 May 2012

10. DATE OF REVISION OF THE TEXT

Detailed information on this medicinal product is available on the website of the European Medicines Agency <http://www.ema.europa.eu/>

ANNEX II

- A. MANUFACTURER(S) OF THE BIOLOGICAL ACTIVE SUBSTANCE AND MANUFACTURER(S) RESPONSIBLE FOR BATCH RELEASE**
- B. CONDITIONS OR RESTRICTIONS REGARDING SUPPLY AND USE**
- C. OTHER CONDITIONS AND REQUIREMENTS OF THE MARKETING AUTHORISATION**
- D. CONDITIONS OR RESTRICTIONS WITH REGARD TO THE SAFE AND EFFECTIVE USE OF THE MEDICINAL PRODUCT**

A. MANUFACTURER(S) OF THE BIOLOGICAL ACTIVE SUBSTANCE AND MANUFACTURER(S) RESPONSIBLE FOR BATCH RELEASE

Name and address of the manufacturer of the biological active substance

Roche Diagnostics GmbH
Werk Penzberg
Nonnenwald 2
82377 Penzberg
Germany

Name and address of the manufacturer responsible for batch release for the pre-filled syringes

Roche Pharma AG
Emil-Barrell-Strasse 1
79639 Grenzach-Wyhlen
Germany

B. CONDITIONS OR RESTRICTIONS REGARDING SUPPLY AND USE

Medicinal product subject to restricted medical prescription (see Annex I: Summary of Product Characteristics, section 4.2).

C. OTHER CONDITIONS AND REQUIREMENTS OF THE MARKETING AUTHORISATION

• **Periodic Safety Update Reports (PSURs)**

The requirements for submission of PSURs for this medicinal product are set out in the list of Union reference dates (EURD list) provided for under Article 107c(7) of Directive 2001/83/EC and any subsequent updates published on the European medicines web-portal.

D. CONDITIONS OR RESTRICTIONS WITH REGARD TO THE SAFE AND EFFECTIVE USE OF THE MEDICINAL PRODUCT

• **Risk Management plan (RMP)**

The marketing authorisation holder (MAH) shall perform the required pharmacovigilance activities and interventions detailed in the agreed RMP presented in Module 1.8.2 of the marketing authorisation and any agreed subsequent updates of the RMP.

An updated RMP should be submitted:

- At the request of the European Medicines Agency;
- Whenever the risk management system is modified, especially as the result of new information being received that may lead to a significant change to the benefit/risk profile or as the result of an important (pharmacovigilance or risk minimisation) milestone being reached.

If the dates for submission of a PSUR and the update of a RMP coincide, they can be submitted at the same time.

ANNEX III
LABELLING AND PACKAGE LEAFLET

A. LABELLING

PARTICULARS TO APPEAR ON THE OUTER PACKAGING

OUTER CARTON 50 micrograms pre-filled syringe

1. NAME OF THE MEDICINAL PRODUCT

MIRCERA 50 micrograms/0.3 ml solution for injection in pre-filled syringe
methoxy polyethylene glycol-epoetin beta

2. STATEMENT OF ACTIVE SUBSTANCE(S)

One pre-filled syringe contains 50 micrograms of methoxy polyethylene glycol-epoetin beta.

3. LIST OF EXCIPIENTS

Sodium dihydrogen phosphate monohydrate, sodium sulphate, mannitol (E421), methionine, poloxamer 188 and water for injections. See leaflet for further information.

4. PHARMACEUTICAL FORM AND CONTENTS

Solution for injection
Each pack contains a pre-filled syringe of 0.3 ml and a needle
Each pack contains 3 pre-filled syringes of 0.3 ml and 3 needles

5. METHOD AND ROUTE(S) OF ADMINISTRATION

For subcutaneous or intravenous use
Read the package leaflet before use
Do not shake

6. SPECIAL WARNING THAT THE MEDICINAL PRODUCT MUST BE STORED OUT OF THE SIGHT AND REACH OF CHILDREN

Keep out of the sight and reach of children

7. OTHER SPECIAL WARNING(S), IF NECESSARY

8. EXPIRY DATE

EXP

9. SPECIAL STORAGE CONDITIONS

Store in a refrigerator
Do not freeze
Keep the pre-filled syringe in the outer carton in order to protect from light

10. SPECIAL PRECAUTIONS FOR DISPOSAL OF UNUSED MEDICINAL PRODUCTS OR WASTE MATERIALS DERIVED FROM SUCH MEDICINAL PRODUCTS, IF APPROPRIATE

11. NAME AND ADDRESS OF THE MARKETING AUTHORISATION HOLDER

Roche Registration GmbH
Emil-Barell-Strasse 1
79639 Grenzach-Wyhlen
Germany

12. MARKETING AUTHORISATION NUMBER(S)

EU/1/07/400/008
EU/1/07/400/023

13. BATCH NUMBER

Lot

14. GENERAL CLASSIFICATION FOR SUPPLY

Medicinal product subject to medical prescription

15. INSTRUCTIONS ON USE

16. INFORMATION IN BRAILLE

mircera 50 mcg

17. UNIQUE IDENTIFIER – 2D BARCODE

2D barcode carrying the unique identifier included.

18. UNIQUE IDENTIFIER - HUMAN READABLE DATA

PC
SN
NN

MINIMUM PARTICULARS TO APPEAR ON SMALL IMMEDIATE PACKAGING UNITS

PRE-FILLED SYRINGES LABEL 50 micrograms

1. NAME OF THE MEDICINAL PRODUCT AND ROUTE(S) OF ADMINISTRATION

MIRCERA 50 mcg/0.3 ml injection
methoxy polyethylene glycol-epoetin beta
SC/IV

2. METHOD OF ADMINISTRATION

Read the package leaflet before use

3. EXPIRY DATE

EXP

4. BATCH NUMBER

Lot

5. CONTENTS BY WEIGHT, BY VOLUME OR BY UNIT

50 mcg/0.3 ml

6. OTHER

PARTICULARS TO APPEAR ON THE OUTER PACKAGING

OUTER CARTON 75 micrograms pre-filled syringe

1. NAME OF THE MEDICINAL PRODUCT

MIRCERA 75 micrograms/0.3 ml solution for injection in pre-filled syringe
methoxy polyethylene glycol-epoetin beta

2. STATEMENT OF ACTIVE SUBSTANCE(S)

One pre-filled syringe contains 75 micrograms of methoxy polyethylene glycol-epoetin beta.

3. LIST OF EXCIPIENTS

Sodium dihydrogen phosphate monohydrate, sodium sulphate, mannitol (E421), methionine, poloxamer 188 and water for injections. See leaflet for further details.

4. PHARMACEUTICAL FORM AND CONTENTS

Solution for injection
Each pack contains a pre-filled syringe of 0.3 ml and a needle
Each pack contains 3 pre-filled syringes of 0.3 ml and 3 needles

5. METHOD AND ROUTE(S) OF ADMINISTRATION

For subcutaneous or intravenous use
Read the package leaflet before use
Do not shake

6. SPECIAL WARNING THAT THE MEDICINAL PRODUCT MUST BE STORED OUT OF THE SIGHT AND REACH OF CHILDREN

Keep out of the sight and reach of children

7. OTHER SPECIAL WARNING(S), IF NECESSARY

8. EXPIRY DATE

EXP

9. SPECIAL STORAGE CONDITIONS

Store in a refrigerator
Do not freeze
Keep the pre-filled syringe in the outer carton in order to protect from light

10. SPECIAL PRECAUTIONS FOR DISPOSAL OF UNUSED MEDICINAL PRODUCTS OR WASTE MATERIALS DERIVED FROM SUCH MEDICINAL PRODUCTS, IF APPROPRIATE

11. NAME AND ADDRESS OF THE MARKETING AUTHORISATION HOLDER

Roche Registration GmbH
Emil-Barell-Strasse 1
79639 Grenzach-Wyhlen
Germany

12. MARKETING AUTHORISATION NUMBER(S)

EU/1/07/400/009
EU/1/07/400/024

13. BATCH NUMBER

Lot

14. GENERAL CLASSIFICATION FOR SUPPLY

Medicinal product subject to medical prescription

15. INSTRUCTIONS ON USE

16. INFORMATION IN BRAILLE

mircera 75 mcg

17. UNIQUE IDENTIFIER – 2D BARCODE

2D barcode carrying the unique identifier included.

18. UNIQUE IDENTIFIER - HUMAN READABLE DATA

PC
SN
NN

MINIMUM PARTICULARS TO APPEAR ON SMALL IMMEDIATE PACKAGING UNITS

PRE-FILLED SYRINGES LABEL 75 micrograms

1. NAME OF THE MEDICINAL PRODUCT AND ROUTE(S) OF ADMINISTRATION

MIRCERA 75 mcg/0.3 ml injection
methoxy polyethylene glycol-epoetin beta
SC/IV

2. METHOD OF ADMINISTRATION

Read the package leaflet before use

3. EXPIRY DATE

EXP

4. BATCH NUMBER

Lot

5. CONTENTS BY WEIGHT, BY VOLUME OR BY UNIT

75 mcg/0.3 ml

6. OTHER

PARTICULARS TO APPEAR ON THE OUTER PACKAGING

OUTER CARTON 100 microgram pre-filled syringe

1. NAME OF THE MEDICINAL PRODUCT

MIRCERA 100 micrograms/0.3 ml solution for injection in pre-filled syringe
methoxy polyethylene glycol-epoetin beta

2. STATEMENT OF ACTIVE SUBSTANCE(S)

One pre-filled syringe contains 100 micrograms of methoxy polyethylene glycol-epoetin beta.

3. LIST OF EXCIPIENTS

Sodium dihydrogen phosphate monohydrate, sodium sulphate, mannitol (E421), methionine, poloxamer 188 and water for injections. See leaflet for further details.

4. PHARMACEUTICAL FORM AND CONTENTS

Solution for injection
Each pack contains a pre-filled syringe of 0.3 ml and a needle

5. METHOD AND ROUTE(S) OF ADMINISTRATION

For subcutaneous or intravenous use
Read the package leaflet before use
Do not shake

6. SPECIAL WARNING THAT THE MEDICINAL PRODUCT MUST BE STORED OUT OF THE SIGHT AND REACH OF CHILDREN

Keep out of the sight and reach of children

7. OTHER SPECIAL WARNING(S), IF NECESSARY

8. EXPIRY DATE

EXP

9. SPECIAL STORAGE CONDITIONS

Store in a refrigerator
Do not freeze
Keep the pre-filled syringe in the outer carton in order to protect from light

10. SPECIAL PRECAUTIONS FOR DISPOSAL OF UNUSED MEDICINAL PRODUCTS OR WASTE MATERIALS DERIVED FROM SUCH MEDICINAL PRODUCTS, IF APPROPRIATE

11. NAME AND ADDRESS OF THE MARKETING AUTHORISATION HOLDER

Roche Registration GmbH
Emil-Barell-Strasse 1
79639 Grenzach-Wyhlen
Germany

12. MARKETING AUTHORISATION NUMBER(S)

EU/1/07/400/010

13. BATCH NUMBER

Lot

14. GENERAL CLASSIFICATION FOR SUPPLY

Medicinal product subject to medical prescription

15. INSTRUCTIONS ON USE

16. INFORMATION IN BRAILLE

mircera 100 mcg

17. UNIQUE IDENTIFIER – 2D BARCODE

2D barcode carrying the unique identifier included.

18. UNIQUE IDENTIFIER - HUMAN READABLE DATA

PC
SN
NN

MINIMUM PARTICULARS TO APPEAR ON SMALL IMMEDIATE PACKAGING UNITS

PRE-FILLED SYRINGES LABEL 100 micrograms

1. NAME OF THE MEDICINAL PRODUCT AND ROUTE(S) OF ADMINISTRATION

MIRCERA 100 mcg/0.3 ml injection
methoxy polyethylene glycol-epoetin beta
SC/IV

2. METHOD OF ADMINISTRATION

Read the package leaflet before use

3. EXPIRY DATE

EXP

4. BATCH NUMBER

Lot

5. CONTENTS BY WEIGHT, BY VOLUME OR BY UNIT

100 mcg/0.3 ml

6. OTHER

PARTICULARS TO APPEAR ON THE OUTER PACKAGING

OUTER CARTON 150 microgram pre-filled syringe

1. NAME OF THE MEDICINAL PRODUCT

MIRCERA 150 micrograms/0.3 ml solution for injection in pre-filled syringe
methoxy polyethylene glycol-epoetin beta

2. STATEMENT OF ACTIVE SUBSTANCE(S)

One pre-filled syringe contains 150 micrograms of methoxy polyethylene glycol-epoetin beta.

3. LIST OF EXCIPIENTS

Sodium dihydrogen phosphate monohydrate, sodium sulphate, mannitol (E421), methionine, poloxamer 188 and water for injections. See leaflet for further details.

4. PHARMACEUTICAL FORM AND CONTENTS

Solution for injection
Each pack contains a pre-filled syringe of 0.3 ml and a needle

5. METHOD AND ROUTE(S) OF ADMINISTRATION

For subcutaneous or intravenous use
Read the package leaflet before use
Do not shake

6. SPECIAL WARNING THAT THE MEDICINAL PRODUCT MUST BE STORED OUT OF THE SIGHT AND REACH OF CHILDREN

Keep out of the sight and reach of children

7. OTHER SPECIAL WARNING(S), IF NECESSARY

8. EXPIRY DATE

EXP

9. SPECIAL STORAGE CONDITIONS

Store in a refrigerator
Do not freeze
Keep the pre-filled syringe in the outer carton in order to protect from light

10. SPECIAL PRECAUTIONS FOR DISPOSAL OF UNUSED MEDICINAL PRODUCTS OR WASTE MATERIALS DERIVED FROM SUCH MEDICINAL PRODUCTS, IF APPROPRIATE

11. NAME AND ADDRESS OF THE MARKETING AUTHORISATION HOLDER

Roche Registration GmbH
Emil-Barell-Strasse 1
79639 Grenzach-Wyhlen
Germany

12. MARKETING AUTHORISATION NUMBER(S)

EU/1/07/400/011

13. BATCH NUMBER

Lot

14. GENERAL CLASSIFICATION FOR SUPPLY

Medicinal product subject to medical prescription

15. INSTRUCTIONS ON USE

16. INFORMATION IN BRAILLE

mircera 150 mcg

17. UNIQUE IDENTIFIER – 2D BARCODE

2D barcode carrying the unique identifier included.

18. UNIQUE IDENTIFIER - HUMAN READABLE DATA

PC
SN
NN

MINIMUM PARTICULARS TO APPEAR ON SMALL IMMEDIATE PACKAGING UNITS

PRE-FILLED SYRINGES LABEL 150 micrograms

1. NAME OF THE MEDICINAL PRODUCT AND ROUTE(S) OF ADMINISTRATION

MIRCERA 150 mcg/0.3 ml injection
methoxy polyethylene glycol-epoetin beta
SC/IV

2. METHOD OF ADMINISTRATION

Read the package leaflet before use

3. EXPIRY DATE

EXP

4. BATCH NUMBER

Lot

5. CONTENTS BY WEIGHT, BY VOLUME OR BY UNIT

150 mcg/0.3 ml

6. OTHER

PARTICULARS TO APPEAR ON THE OUTER PACKAGING

OUTER CARTON 200 micrograms pre-filled syringe

1. NAME OF THE MEDICINAL PRODUCT

MIRCERA 200 micrograms/0.3 ml solution for injection in pre-filled syringe
methoxy polyethylene glycol-epoetin beta

2. STATEMENT OF ACTIVE SUBSTANCE(S)

One pre-filled syringe contains 200 micrograms of methoxy polyethylene glycol-epoetin beta.

3. LIST OF EXCIPIENTS

Sodium dihydrogen phosphate monohydrate, sodium sulphate, mannitol (E421), methionine, poloxamer 188 and water for injections. See leaflet for further details.

4. PHARMACEUTICAL FORM AND CONTENTS

Solution for injection
Each pack contains a pre-filled syringe of 0.3 ml and a needle

5. METHOD AND ROUTE(S) OF ADMINISTRATION

For subcutaneous or intravenous use
Read the package leaflet before use
Do not shake

6. SPECIAL WARNING THAT THE MEDICINAL PRODUCT MUST BE STORED OUT OF THE SIGHT AND REACH OF CHILDREN

Keep out of the sight and reach of children

7. OTHER SPECIAL WARNING(S), IF NECESSARY

8. EXPIRY DATE

EXP

9. SPECIAL STORAGE CONDITIONS

Store in a refrigerator
Do not freeze
Keep the pre-filled syringe in the outer carton in order to protect from light

10. SPECIAL PRECAUTIONS FOR DISPOSAL OF UNUSED MEDICINAL PRODUCTS OR WASTE MATERIALS DERIVED FROM SUCH MEDICINAL PRODUCTS, IF APPROPRIATE

11. NAME AND ADDRESS OF THE MARKETING AUTHORISATION HOLDER

Roche Registration GmbH
Emil-Barell-Strasse 1
79639 Grenzach-Wyhlen
Germany

12. MARKETING AUTHORISATION NUMBER(S)

EU/1/07/400/012

13. BATCH NUMBER

Lot

14. GENERAL CLASSIFICATION FOR SUPPLY

Medicinal product subject to medical prescription

15. INSTRUCTIONS ON USE

16. INFORMATION IN BRAILLE

mircera 200 mcg

17. UNIQUE IDENTIFIER – 2D BARCODE

2D barcode carrying the unique identifier included.

18. UNIQUE IDENTIFIER - HUMAN READABLE DATA

PC
SN
NN

MINIMUM PARTICULARS TO APPEAR ON SMALL IMMEDIATE PACKAGING UNITS

PRE-FILLED SYRINGES LABEL 200 micrograms

1. NAME OF THE MEDICINAL PRODUCT AND ROUTE(S) OF ADMINISTRATION

MIRCERA 200 mcg/0.3 ml injection
methoxy polyethylene glycol-epoetin beta
SC/IV

2. METHOD OF ADMINISTRATION

Read the package leaflet before use

3. EXPIRY DATE

EXP

4. BATCH NUMBER

Lot

5. CONTENTS BY WEIGHT, BY VOLUME OR BY UNIT

200 mcg/0.3 ml

6. OTHER

PARTICULARS TO APPEAR ON THE OUTER PACKAGING

OUTER CARTON 250 microgram pre-filled syringe

1. NAME OF THE MEDICINAL PRODUCT

MIRCERA 250 micrograms/0.3 ml solution for injection in pre-filled syringe
methoxy polyethylene glycol-epoetin beta

2. STATEMENT OF ACTIVE SUBSTANCE(S)

One pre-filled syringe contains 250 micrograms of methoxy polyethylene glycol-epoetin beta.

3. LIST OF EXCIPIENTS

Sodium dihydrogen phosphate monohydrate, sodium sulphate, mannitol (E421), methionine, poloxamer 188 and water for injections. See leaflet for further details.

4. PHARMACEUTICAL FORM AND CONTENTS

Solution for injection
Each pack contains a pre-filled syringe of 0.3 ml and a needle

5. METHOD AND ROUTE(S) OF ADMINISTRATION

For subcutaneous or intravenous use
Read the package leaflet before use
Do not shake

6. SPECIAL WARNING THAT THE MEDICINAL PRODUCT MUST BE STORED OUT OF THE SIGHT AND REACH OF CHILDREN

Keep out of the sight and reach of children

7. OTHER SPECIAL WARNING(S), IF NECESSARY

8. EXPIRY DATE

EXP

9. SPECIAL STORAGE CONDITIONS

Store in a refrigerator
Do not freeze
Keep the pre-filled syringe in the outer carton in order to protect from light

10. SPECIAL PRECAUTIONS FOR DISPOSAL OF UNUSED MEDICINAL PRODUCTS OR WASTE MATERIALS DERIVED FROM SUCH MEDICINAL PRODUCTS, IF APPROPRIATE

11. NAME AND ADDRESS OF THE MARKETING AUTHORISATION HOLDER

Roche Registration GmbH
Emil-Barell-Strasse 1
79639 Grenzach-Wyhlen
Germany

12. MARKETING AUTHORISATION NUMBER(S)

EU/1/07/400/013

13. BATCH NUMBER

Lot

14. GENERAL CLASSIFICATION FOR SUPPLY

Medicinal product subject to medical prescription

15. INSTRUCTIONS ON USE

16. INFORMATION IN BRAILLE

mircera 250 mcg

17. UNIQUE IDENTIFIER – 2D BARCODE

2D barcode carrying the unique identifier included.

18. UNIQUE IDENTIFIER - HUMAN READABLE DATA

PC
SN
NN

MINIMUM PARTICULARS TO APPEAR ON SMALL IMMEDIATE PACKAGING UNITS

PRE-FILLED SYRINGES LABEL 250 micrograms

1. NAME OF THE MEDICINAL PRODUCT AND ROUTE(S) OF ADMINISTRATION

MIRCERA 250 mcg/0.3 ml injection
methoxy polyethylene glycol-epoetin beta
SC/IV

2. METHOD OF ADMINISTRATION

Read the package leaflet before use

3. EXPIRY DATE

EXP

4. BATCH NUMBER

Lot

5. CONTENTS BY WEIGHT, BY VOLUME OR BY UNIT

250 mcg/0.3 ml

6. OTHER

PARTICULARS TO APPEAR ON THE OUTER PACKAGING

OUTER CARTON 30 micrograms pre-filled syringe

1. NAME OF THE MEDICINAL PRODUCT

MIRCERA 30 micrograms/0.3 ml solution for injection in pre-filled syringe
methoxy polyethylene glycol-epoetin beta

2. STATEMENT OF ACTIVE SUBSTANCE(S)

One pre-filled syringe contains 30 micrograms of methoxy polyethylene glycol-epoetin beta.

3. LIST OF EXCIPIENTS

Sodium dihydrogen phosphate monohydrate, sodium sulphate, mannitol (E421), methionine, poloxamer 188 and water for injections. See leaflet for further details.

4. PHARMACEUTICAL FORM AND CONTENTS

Solution for injection
Each pack contains a pre-filled syringe of 0.3 ml and a needle
Each pack contains 3 pre-filled syringes of 0.3 ml and 3 needles

5. METHOD AND ROUTE(S) OF ADMINISTRATION

For subcutaneous or intravenous use
Read the package leaflet before use
Do not shake

6. SPECIAL WARNING THAT THE MEDICINAL PRODUCT MUST BE STORED OUT OF THE SIGHT AND REACH OF CHILDREN

Keep out of the sight and reach of children

7. OTHER SPECIAL WARNING(S), IF NECESSARY

8. EXPIRY DATE

EXP

9. SPECIAL STORAGE CONDITIONS

Store in a refrigerator
Do not freeze
Keep the pre-filled syringe in the outer carton in order to protect from light

10. SPECIAL PRECAUTIONS FOR DISPOSAL OF UNUSED MEDICINAL PRODUCTS OR WASTE MATERIALS DERIVED FROM SUCH MEDICINAL PRODUCTS, IF APPROPRIATE

11. NAME AND ADDRESS OF THE MARKETING AUTHORISATION HOLDER

Roche Registration GmbH
Emil-Barell-Strasse 1
79639 Grenzach-Wyhlen
Germany

12. MARKETING AUTHORISATION NUMBER(S)

EU/1/07/400/017
EU/1/07/400/022

13. BATCH NUMBER

Lot

14. GENERAL CLASSIFICATION FOR SUPPLY

Medicinal product subject to medical prescription

15. INSTRUCTIONS ON USE

16. INFORMATION IN BRAILLE

mircera 30 mcg

17. UNIQUE IDENTIFIER – 2D BARCODE

2D barcode carrying the unique identifier included.

18. UNIQUE IDENTIFIER - HUMAN READABLE DATA

PC
SN
NN

MINIMUM PARTICULARS TO APPEAR ON SMALL IMMEDIATE PACKAGING UNITS

PRE-FILLED SYRINGES LABEL 30 micrograms

1. NAME OF THE MEDICINAL PRODUCT AND ROUTE(S) OF ADMINISTRATION

MIRCERA 30 mcg/0.3 ml injection
methoxy polyethylene glycol-epoetin beta
SC/IV

2. METHOD OF ADMINISTRATION

Read the package leaflet before use

3. EXPIRY DATE

EXP

4. BATCH NUMBER

Lot

5. CONTENTS BY WEIGHT, BY VOLUME OR BY UNIT

30 mcg/0.3 ml

6. OTHER

PARTICULARS TO APPEAR ON THE OUTER PACKAGING

OUTER CARTON 40 micrograms pre-filled syringe

1. NAME OF THE MEDICINAL PRODUCT

MIRCERA 40 micrograms/0.3 ml solution for injection in pre-filled syringe
methoxy polyethylene glycol-epoetin beta

2. STATEMENT OF ACTIVE SUBSTANCE(S)

One pre-filled syringe contains 40 micrograms of methoxy polyethylene glycol-epoetin beta.

3. LIST OF EXCIPIENTS

Sodium dihydrogen phosphate monohydrate, sodium sulphate, mannitol (E421), methionine, poloxamer 188 and water for injections. See leaflet for further details.

4. PHARMACEUTICAL FORM AND CONTENTS

Solution for injection
Each pack contains a pre-filled syringe of 0.3 ml and a needle

5. METHOD AND ROUTE(S) OF ADMINISTRATION

For subcutaneous or intravenous use
Read the package leaflet before use
Do not shake

6. SPECIAL WARNING THAT THE MEDICINAL PRODUCT MUST BE STORED OUT OF THE SIGHT AND REACH OF CHILDREN

Keep out of the sight and reach of children

7. OTHER SPECIAL WARNING(S), IF NECESSARY

8. EXPIRY DATE

EXP

9. SPECIAL STORAGE CONDITIONS

Store in a refrigerator
Do not freeze
Keep the pre-filled syringe in the outer carton in order to protect from light

10. SPECIAL PRECAUTIONS FOR DISPOSAL OF UNUSED MEDICINAL PRODUCTS OR WASTE MATERIALS DERIVED FROM SUCH MEDICINAL PRODUCTS, IF APPROPRIATE

11. NAME AND ADDRESS OF THE MARKETING AUTHORISATION HOLDER

Roche Registration GmbH
Emil-Barell-Strasse 1
79639 Grenzach-Wyhlen
Germany

12. MARKETING AUTHORISATION NUMBER(S)

EU/1/07/400/018

13. BATCH NUMBER

Lot

14. GENERAL CLASSIFICATION FOR SUPPLY

Medicinal product subject to medical prescription

15. INSTRUCTIONS ON USE

16. INFORMATION IN BRAILLE

mircera 40 mcg

17. UNIQUE IDENTIFIER – 2D BARCODE

2D barcode carrying the unique identifier included.

18. UNIQUE IDENTIFIER - HUMAN READABLE DATA

PC
SN
NN

MINIMUM PARTICULARS TO APPEAR ON SMALL IMMEDIATE PACKAGING UNITS

PRE-FILLED SYRINGES LABEL 40 micrograms

1. NAME OF THE MEDICINAL PRODUCT AND ROUTE(S) OF ADMINISTRATION

MIRCERA 40 mcg/0.3 ml injection
methoxy polyethylene glycol-epoetin beta
SC/IV

2. METHOD OF ADMINISTRATION

Read the package leaflet before use

3. EXPIRY DATE

EXP

4. BATCH NUMBER

Lot

5. CONTENTS BY WEIGHT, BY VOLUME OR BY UNIT

40 mcg/0.3 ml

6. OTHER

PARTICULARS TO APPEAR ON THE OUTER PACKAGING

OUTER CARTON 60 micrograms pre-filled syringe

1. NAME OF THE MEDICINAL PRODUCT

MIRCERA 60 micrograms/0.3 ml solution for injection in pre-filled syringe
methoxy polyethylene glycol-epoetin beta

2. STATEMENT OF ACTIVE SUBSTANCE(S)

One pre-filled syringe contains 60 micrograms of methoxy polyethylene glycol-epoetin beta.

3. LIST OF EXCIPIENTS

Sodium dihydrogen phosphate monohydrate, sodium sulphate, mannitol (E421), methionine, poloxamer 188 and water for injections. See leaflet for further details.

4. PHARMACEUTICAL FORM AND CONTENTS

Solution for injection
Each pack contains a pre-filled syringe of 0.3 ml and a needle

5. METHOD AND ROUTE(S) OF ADMINISTRATION

For subcutaneous or intravenous use
Read the package leaflet before use
Do not shake

6. SPECIAL WARNING THAT THE MEDICINAL PRODUCT MUST BE STORED OUT OF THE SIGHT AND REACH OF CHILDREN

Keep out of the sight and reach of children

7. OTHER SPECIAL WARNING(S), IF NECESSARY

8. EXPIRY DATE

EXP

9. SPECIAL STORAGE CONDITIONS

Store in a refrigerator
Do not freeze
Keep the pre-filled syringe in the outer carton in order to protect from light

10. SPECIAL PRECAUTIONS FOR DISPOSAL OF UNUSED MEDICINAL PRODUCTS OR WASTE MATERIALS DERIVED FROM SUCH MEDICINAL PRODUCTS, IF APPROPRIATE

11. NAME AND ADDRESS OF THE MARKETING AUTHORISATION HOLDER

Roche Registration GmbH
Emil-Barell-Strasse 1
79639 Grenzach-Wyhlen
Germany

12. MARKETING AUTHORISATION NUMBER(S)

EU/1/07/400/019

13. BATCH NUMBER

Lot

14. GENERAL CLASSIFICATION FOR SUPPLY

Medicinal product subject to medical prescription

15. INSTRUCTIONS ON USE

16. INFORMATION IN BRAILLE

mircera 60 mcg

17. UNIQUE IDENTIFIER – 2D BARCODE

2D barcode carrying the unique identifier included.

18. UNIQUE IDENTIFIER - HUMAN READABLE DATA

PC
SN
NN

MINIMUM PARTICULARS TO APPEAR ON SMALL IMMEDIATE PACKAGING UNITS

PRE-FILLED SYRINGES LABEL 60 micrograms

1. NAME OF THE MEDICINAL PRODUCT AND ROUTE(S) OF ADMINISTRATION

MIRCERA 60 mcg/0.3 ml injection
methoxy polyethylene glycol-epoetin beta
SC/IV

2. METHOD OF ADMINISTRATION

Read the package leaflet before use

3. EXPIRY DATE

EXP

4. BATCH NUMBER

Lot

5. CONTENTS BY WEIGHT, BY VOLUME OR BY UNIT

60 mcg/0.3 ml

6. OTHER

PARTICULARS TO APPEAR ON THE OUTER PACKAGING

OUTER CARTON 120 micrograms pre-filled syringe

1. NAME OF THE MEDICINAL PRODUCT

MIRCERA 120 micrograms/0.3 ml solution for injection in pre-filled syringe
methoxy polyethylene glycol-epoetin beta

2. STATEMENT OF ACTIVE SUBSTANCE(S)

One pre-filled syringe contains 120 micrograms of methoxy polyethylene glycol-epoetin beta.

3. LIST OF EXCIPIENTS

Sodium dihydrogen phosphate monohydrate, sodium sulphate, mannitol (E421), methionine, poloxamer 188 and water for injections. See leaflet for further details.

4. PHARMACEUTICAL FORM AND CONTENTS

Solution for injection
Each pack contains a pre-filled syringe of 0.3 ml and a needle

5. METHOD AND ROUTE(S) OF ADMINISTRATION

For subcutaneous or intravenous use
Read the package leaflet before use
Do not shake

6. SPECIAL WARNING THAT THE MEDICINAL PRODUCT MUST BE STORED OUT OF THE SIGHT AND REACH OF CHILDREN

Keep out of the sight and reach of children

7. OTHER SPECIAL WARNING(S), IF NECESSARY

8. EXPIRY DATE

EXP

9. SPECIAL STORAGE CONDITIONS

Store in a refrigerator
Do not freeze
Keep the pre-filled syringe in the outer carton in order to protect from light

10. SPECIAL PRECAUTIONS FOR DISPOSAL OF UNUSED MEDICINAL PRODUCTS OR WASTE MATERIALS DERIVED FROM SUCH MEDICINAL PRODUCTS, IF APPROPRIATE

11. NAME AND ADDRESS OF THE MARKETING AUTHORISATION HOLDER

Roche Registration GmbH
Emil-Barell-Strasse 1
79639 Grenzach-Wyhlen
Germany

12. MARKETING AUTHORISATION NUMBER(S)

EU/1/07/400/020

13. BATCH NUMBER

Lot

14. GENERAL CLASSIFICATION FOR SUPPLY

Medicinal product subject to medical prescription

15. INSTRUCTIONS ON USE

16. INFORMATION IN BRAILLE

mircera 120 mcg

17. UNIQUE IDENTIFIER – 2D BARCODE

2D barcode carrying the unique identifier included.

18. UNIQUE IDENTIFIER - HUMAN READABLE DATA

PC
SN
NN

MINIMUM PARTICULARS TO APPEAR ON SMALL IMMEDIATE PACKAGING UNITS

PRE-FILLED SYRINGES LABEL 120 micrograms

1. NAME OF THE MEDICINAL PRODUCT AND ROUTE(S) OF ADMINISTRATION

MIRCERA 120 mcg/0.3 ml injection
methoxy polyethylene glycol-epoetin beta
SC/IV

2. METHOD OF ADMINISTRATION

Read the package leaflet before use

3. EXPIRY DATE

EXP

4. BATCH NUMBER

Lot

5. CONTENTS BY WEIGHT, BY VOLUME OR BY UNIT

120 mcg/0.3 ml

6. OTHER

PARTICULARS TO APPEAR ON THE OUTER PACKAGING

OUTER CARTON 360 micrograms pre-filled syringe

1. NAME OF THE MEDICINAL PRODUCT

MIRCERA 360 micrograms/0.6 ml solution for injection in pre-filled syringe
methoxy polyethylene glycol-epoetin beta

2. STATEMENT OF ACTIVE SUBSTANCE(S)

One pre-filled syringe contains 360 micrograms of methoxy polyethylene glycol-epoetin beta.

3. LIST OF EXCIPIENTS

Sodium dihydrogen phosphate monohydrate, sodium sulphate, mannitol (E421), methionine, poloxamer 188 and water for injections. See leaflet for further details.

4. PHARMACEUTICAL FORM AND CONTENTS

Solution for injection
Each pack contains a pre-filled syringe of 0.6 ml and a needle

5. METHOD AND ROUTE(S) OF ADMINISTRATION

For subcutaneous or intravenous use
Read the package leaflet before use
Do not shake

6. SPECIAL WARNING THAT THE MEDICINAL PRODUCT MUST BE STORED OUT OF THE SIGHT AND REACH OF CHILDREN

Keep out of the sight and reach of children

7. OTHER SPECIAL WARNING(S), IF NECESSARY

8. EXPIRY DATE

EXP

9. SPECIAL STORAGE CONDITIONS

Store in a refrigerator
Do not freeze
Keep the pre-filled syringe in the outer carton in order to protect from light

10. SPECIAL PRECAUTIONS FOR DISPOSAL OF UNUSED MEDICINAL PRODUCTS OR WASTE MATERIALS DERIVED FROM SUCH MEDICINAL PRODUCTS, IF APPROPRIATE

11. NAME AND ADDRESS OF THE MARKETING AUTHORISATION HOLDER

Roche Registration GmbH
Emil-Barell-Strasse 1
79639 Grenzach-Wyhlen
Germany

12. MARKETING AUTHORISATION NUMBER(S)

EU/1/07/400/021

13. BATCH NUMBER

Lot

14. GENERAL CLASSIFICATION FOR SUPPLY

Medicinal product subject to medical prescription

15. INSTRUCTIONS ON USE

16. INFORMATION IN BRAILLE

mircera 360 mcg

17. UNIQUE IDENTIFIER – 2D BARCODE

2D barcode carrying the unique identifier included.

18. UNIQUE IDENTIFIER - HUMAN READABLE DATA

PC
SN
NN

MINIMUM PARTICULARS TO APPEAR ON SMALL IMMEDIATE PACKAGING UNITS

PRE-FILLED SYRINGES LABEL 360 micrograms

1. NAME OF THE MEDICINAL PRODUCT AND ROUTE(S) OF ADMINISTRATION

MIRCERA 360 mcg/0.6 ml injection
methoxy polyethylene glycol-epoetin beta
SC/IV

2. METHOD OF ADMINISTRATION

Read the package leaflet before use

3. EXPIRY DATE

EXP

4. BATCH NUMBER

Lot

5. CONTENTS BY WEIGHT, BY VOLUME OR BY UNIT

360 mcg/0.6 ml

6. OTHER

B. PACKAGE LEAFLET

Package leaflet: Information for the user

MIRCERA

30 micrograms/0.3 ml solution for injection in pre-filled syringe
40 micrograms/0.3 ml solution for injection in pre-filled syringe
50 micrograms/0.3 ml solution for injection in pre-filled syringe
60 micrograms/0.3 ml solution for injection in pre-filled syringe
75 micrograms/0.3 ml solution for injection in pre-filled syringe
100 micrograms/0.3 ml solution for injection in pre-filled syringe
120 micrograms/0.3 ml solution for injection in pre-filled syringe
150 micrograms/0.3 ml solution for injection in pre-filled syringe
200 micrograms/0.3 ml solution for injection in pre-filled syringe
250 micrograms/0.3 ml solution for injection in pre-filled syringe
360 micrograms/0.6 ml solution for injection in pre-filled syringe

methoxy polyethylene glycol-epoetin beta

Read all of this leaflet carefully before you start using this medicine because it contains important information for you.

- Keep this leaflet. You may need to read it again.
- If you have any further questions, ask your doctor or pharmacist.
- This medicine has been prescribed for you only. Do not pass it on to others. It may harm them, even if their signs of illness are the same as yours.
- If you get any side effects, talk to your doctor. This includes any possible side effects not listed in this leaflet. See section 4.

What is in this leaflet:

1. What MIRCERA is and what it is used for
2. What you need to know before you use MIRCERA
3. How to use MIRCERA
4. Possible side effects
5. How to store MIRCERA
6. Contents of the pack and other information

1. What MIRCERA is and what it is used for

This medicine is prescribed to you because you have anaemia caused by your chronic kidney disease and associated with typical symptoms, such as tiredness, weakness and shortness of breath. This means that you have too few red blood cells and your haemoglobin level is too low (your body's tissues might not receive enough oxygen).

MIRCERA is indicated to treat only the symptomatic anaemia caused by chronic kidney disease in adult patients and in paediatric patients (aged 3 months to less than 18 years) on erythropoiesis stimulating agent (ESA) maintenance treatment after their haemoglobin level was stabilised with the previous ESA.

MIRCERA is a medicine produced by gene-technology. Like the natural hormone erythropoietin, MIRCERA increases the number of red blood cells and haemoglobin level in your blood.

2. What you need to know before you use MIRCERA

Do not use MIRCERA

- if you are allergic to methoxy polyethylene glycol-epoetin beta or to any of the other ingredients of this medicine (listed in section 6)
- if you have high blood pressure that cannot be controlled

Warnings and precautions

The safety and efficacy of MIRCERA therapy in other indications, including anaemia in patients with cancer, has not been established.

The safety and efficacy of MIRCERA therapy in paediatric patients have only been established in patients whose haemoglobin level has been previously stabilised by treatment with an ESA.

Before treatment with MIRCERA

- A condition called Pure Red Cell Aplasia (PRCA, stopped or reduced production of red blood cells) due to anti-erythropoietin antibodies was observed in some patients treated with erythropoiesis stimulating agents (ESAs), including MIRCERA.
- If your doctor suspects or confirms that you have these antibodies in your blood, you must not be treated with MIRCERA.
- If you are a patient with hepatitis C and you receive interferon and ribavirin you should discuss this with your doctor because a combination of ESAs with interferon and ribavirin has led to a loss of effect and development of PRCA, a severe form of anemia, in rare cases. ESAs are not approved in the management of anaemia associated with hepatitis C.
- If you are a patient with chronic kidney disease and anemia treated with an ESA and are also a cancer patient you should be aware that ESAs, might have a negative impact on your condition. You should discuss options for anemia treatment with your doctor.
- It is not known if MIRCERA has a different effect in patients with haemoglobinopathies (disorders associated with abnormal haemoglobin), past or present bleeding, seizures or with a high blood platelet count. If you have any of these conditions, your doctor will discuss it with you and must treat you with caution.
- Healthy people should not use MIRCERA. Using it can lead to too high haemoglobin levels and cause problems with the heart or blood vessels that may be life-threatening.

During treatment with MIRCERA

- If you are a patient with chronic renal failure, and particularly if you do not respond properly to MIRCERA, your doctor will check your dose of MIRCERA because repeatedly increasing your dose of MIRCERA if you are not responding to treatment may increase the risk of having a problem of the heart or the blood vessels and could increase risk of myocardial infarction, stroke and death.
- Your doctor may initiate treatment with MIRCERA if your haemoglobin level is 10 g/dl (6.21 mmol/l) or less. After initiation of therapy, your doctor will seek to maintain your haemoglobin level between 10 and 12 g/dl (7.45 mmol/l).
- Your doctor will check the amount of iron in your blood before and during MIRCERA treatment. If the amount is too low your doctor may give you an additional iron supplement.
- Your doctor will check your blood pressure before and during your MIRCERA treatment. If your blood pressure is high and cannot be controlled, either by appropriate medicines or a special diet, your doctor will interrupt your MIRCERA treatment or reduce the dose.
- Your doctor will check that your haemoglobin does not exceed a certain level, as high haemoglobin could put you at risk of having a problem of the heart or the blood vessels and could increase risk of thrombosis, including pulmonary embolism, myocardial infarction, stroke and death.
- Contact your doctor if you feel tired, weak or have shortness of breath, because this could mean that your MIRCERA treatment is not effective. Your doctor will check that you do not have other causes of anaemia and may perform blood tests or examine your bone marrow. If you have developed PRCA, your MIRCERA treatment will be discontinued. You will not receive another ESA and your doctor will treat you for this condition.

Children and adolescents

MIRCERA can be used for the treatment of children and adolescents, 3 months of age to less than 18 years, with anaemia associated with chronic kidney disease. They should be stabilised on ESA maintenance treatment prior to switching to MIRCERA and may or may not be receiving dialysis. Talk to your doctor, pharmacist or nurse before you are given this medicine if you, or your child, are under 18 years of age.

Take special care with other products that stimulate red blood cell production: MIRCERA is one of a group of products that stimulate the production of red blood cells like the human protein erythropoietin does. Your healthcare professional will always record the exact product you are using.

Serious skin reactions including Stevens-Johnson syndrome (SJS) and toxic epidermal necrolysis (TEN) have been reported in association with epoetin treatment. SJS/TEN can appear initially as reddish target-like spots or circular patches often with central blisters on the trunk. Also, ulcers of mouth, throat, nose, genitals and eyes (red and swollen eyes) can occur. These serious skin rashes are often preceded by fever and/or flu-like symptoms. The rashes may progress to widespread peeling of the skin and life-threatening complications.

If you develop a serious rash or another of these skin symptoms stop taking Mircera and contact your doctor or seek medical attention immediately.

Other medicines and MIRCERA

Tell your doctor or pharmacist if you are using, have recently used or might use any other medicines. No interaction studies have been performed. There is no evidence that MIRCERA interacts with other medicines.

MIRCERA with food and drink

Food and drink do not affect MIRCERA.

Pregnancy, breast-feeding and fertility

Ask your doctor or pharmacist for advice before taking any medicine.

MIRCERA has not been studied in pregnant or breast-feeding women.

Tell your doctor if you are pregnant, think you are pregnant or intend to become pregnant. Your doctor will consider what is the best treatment for you during pregnancy.

Tell your doctor if you are breast-feeding or intend to breast-feed. Your doctor will advise if you should stop or continue breast-feeding and stop or continue your treatment.

MIRCERA has not shown evidence of impaired fertility in animals. The potential risk for humans is unknown.

Driving and using machines

MIRCERA does not affect your ability to drive and use machines.

Important information about some of the ingredients of MIRCERA

This medicine contains less than 1 mmol sodium (23 mg) per ml, that is to say it is essentially 'sodium-free'.

3. How to use MIRCERA

Always use this medicine exactly as your doctor has told you. Check with your doctor or pharmacist if you are not sure.

Your doctor will use the lowest effective dose to control the symptoms of your anaemia.

If you do not respond adequately to MIRCERA, your doctor will check your dose and will inform you if you need to change doses of MIRCERA.

Treatment with MIRCERA must be started under the supervision of a healthcare professional. Further injections can be given by a healthcare professional or, after you have been trained, as an adult, you can inject MIRCERA yourself. Children and adolescents less than 18 years should not self-inject MIRCERA, the administration should be performed by a healthcare professional or trained adult caregiver (follow the instructions at the end of this leaflet on how to use MIRCERA pre-filled syringe to give to yourself or another individual an injection.)

MIRCERA can be injected under the skin in the abdomen, arm or thigh; or into a vein. Your doctor will decide which is best for you.

Your doctor will carry out regular blood tests to monitor how your anaemia is responding to treatment by measuring your haemoglobin level.

- **If you are an adult not currently treated with an ESA**

If you are not on dialysis, the recommended starting dose of MIRCERA is 1.2 micrograms for every kilogram of your body weight to be administered under the skin once every month as a single injection. Alternatively, your doctor may decide to administer a starting dose of MIRCERA of 0.6 micrograms for every kilogram of your body weight. The dose is to be administered once every two weeks as a single injection under the skin or into a vein. Once your anaemia is corrected your doctor may change your dosing to once a month administration.

If you are on dialysis, the recommended starting dose is 0.6 micrograms for every kilogram of your body weight. The dose is to be administered once every two weeks as a single injection under the skin or into a vein. Once your anaemia is corrected your doctor may change your dosing to once a month administration.

Your doctor may increase or decrease your dose or temporarily stop your treatment to adjust your haemoglobin level, as appropriate for you. Dose changes will not be made more often than once a month.

- **If you are currently being treated with another ESA**

Your doctor may replace your current medicine with MIRCERA. Your doctor will decide to treat you with MIRCERA administered as a single injection once a month. Your doctor will calculate your MIRCERA starting dose based on the last dose of your previous medicine. The first MIRCERA dose will be given on the planned injection day of your previous medicine.

Your doctor may increase or decrease your dose or temporarily stop your treatment to adjust your haemoglobin to an appropriate level for you. Dose changes will not be made more often than once a month.

If you use more MIRCERA than you should

Please contact your doctor or pharmacist if you used too large a dose of MIRCERA as it may be necessary to perform some blood tests and interrupt your treatment.

If you forget to use MIRCERA

If you miss a dose of MIRCERA administer the missed dose as soon as you remember and talk to your doctor about when to use the next doses.

If you stop using MIRCERA

Treatment with MIRCERA is normally long-term. It can, however, be stopped on the advice of your doctor at any time.

If you have any further questions on the use of this medicine, ask your doctor or pharmacist.

4. Possible side effects

Like all medicines, this medicine can cause side effects, although not everybody gets them.

The frequency of possible side effects listed below:

A common side effect (may affect up to 1 in 10 people) is hypertension (high blood pressure).

Uncommon side effects (may affect up to 1 in 100 people) are:

- headache
- vascular access site thrombosis (blood clots in your dialysis access)
- thrombocytopenia
- thrombosis

Rare side effects (may affect up to 1 in 1000 people) are:

- hypertensive encephalopathy (very high blood pressure that can result in headache, especially sudden, stabbing, migraine-like headache, confusion, speech disturbances, fits or convulsions).
- pulmonary embolism.
- maculo-papular rash (red skin reaction that can include pimples or spots)
- hot flush
- hypersensitivity (allergic reaction that can cause unusual wheezing or difficulty in breathing; swollen tongue, face or throat, or swelling around the injection site, or make you feel light-headed, faint or cause you to collapse).

If you have these symptoms please contact your doctor immediately to receive treatment.

During clinical studies patients had a slight decrease in their platelet blood counts. There have been reports of platelet counts below the normal range (thrombocytopenia) in the post-marketing setting.

Hypersensitivity reactions, including cases of anaphylactic reaction and serious skin rashes including Stevens-Johnson syndrome (SJS) and toxic epidermal necrolysis have been reported in association with epoetin treatment. These can appear as reddish target-like macules or circular patches often with central blisters on the trunk, skin peeling, ulcers of mouth, throat, nose, genitals and eyes and can be preceded by fever and flu-like symptoms. Stop using Mircera if you develop these symptoms and contact your doctor or seek medical attention immediately, see also section 2.

As with other ESAs, cases of thrombosis, including pulmonary embolism, have been reported in the post-marketing setting.

A condition called Pure Red Cell Aplasia (PRCA, stopped or reduced production of red blood cells) due to anti-erythropoietin antibodies was observed in some patients treated with ESAs, including MIRCERA.

Reporting of side effects

If you get any side effects, talk to your doctor or pharmacist. This includes any possible side effects not listed in this leaflet. You can also report side effects directly via [the national reporting system listed in Appendix V*](#). By reporting side effects you can help provide more information on the safety of this medicine.

5. How to store MIRCERA

Keep this medicine out of the sight and reach of children.

Do not use this medicine after the expiry date which is stated on the outer carton and pre-filled syringe label after 'EXP'. The expiry date refers to the last day of that month.

Store in a refrigerator (2 °C – 8 °C). Do not freeze.

Keep the pre-filled syringe in the outer carton in order to protect from light.

You may remove your MIRCERA pre-filled syringe from the refrigerator and store it at a room temperature not above 30 °C for a single period of one month. During this period when you have stored MIRCERA at a room temperature not above 30 °C you may not put MIRCERA back in the refrigerator before use. Once you have removed your medicine from the refrigerator you must use it within this period of one month.

Only solutions which are clear, colourless to slightly yellowish and free of visible particles must be injected.

Do not throw away any medicines via wastewater or household waste.

Ask your pharmacist how to throw away medicines you no longer use. These measures will help protect the environment.

6. Contents of the pack and other information

What MIRCERA contains

- The active substance is methoxy polyethylene glycol-epoetin beta. One pre-filled syringe contains:
30, 40, 50, 60, 75, 100, 120, 150, 200 or 250 micrograms in 0.3 ml and 360 micrograms in 0.6 ml.
- The other ingredients are sodium dihydrogen phosphate monohydrate, sodium sulphate, mannitol (E421), methionine, poloxamer 188 and water for injections.

What MIRCERA looks like and contents of the pack

MIRCERA is a solution for injection in pre-filled syringe.

The solution is clear, colourless to slightly yellowish and free of visible particles.

MIRCERA comes in pre-filled syringes with laminated plunger stopper and tip cap with one needle 27G1/2. Each pre-filled syringe contains 0.3 ml or 0.6 ml. Pre-filled syringes are not designed for administration of partial doses. MIRCERA is available, for all strengths, in pack sizes of 1 and also packsize of 3 for the strengths 30, 50, 75 micrograms/0.3ml. Not all pack sizes may be marketed.

Marketing Authorisation Holder

Roche Registration GmbH
Emil-Barell-Strasse 1
79639 Grenzach-Wyhlen
Germany

Manufacturer

Roche Pharma AG
Emil-Barell-Strasse 1
79639 Grenzach-Wyhlen
Germany

For any information about this medicinal product, please contact the local representative of the Marketing Authorisation Holder:

België/Belgique/Belgien

N.V. Roche S.A.
Tél/Tel: +32 (0) 2 525 82 11

България

Рош България ЕООД
Тел: +359 2 474 5444

Česká republika

Roche s. r. o.
Tel: +420 - 2 20382111

Danmark

Roche Pharmaceuticals A/S
Tlf: +45 - 36 39 99 99

Deutschland

Roche Pharma AG
Tel: +49 (0) 7624 140

Eesti

Roche Eesti OÜ
Tel: + 372 - 6 177 380

Ελλάδα

Roche (Hellas) A.E.
Τηλ: +30 210 61 66 100

España

Roche Farma S.A.
Tel: +34 - 91 324 81 00

France

Roche
Tél: +33 (0) 1 47 61 40 00

Hrvatska

Roche d.o.o.
Tel: +385 1 4722 333

Ireland

Roche Products (Ireland) Ltd.
Tel: +353 (0) 1 469 0700

Ísland

Roche Pharmaceuticals A/S
c/o Icepharma hf
Sími: +354 540 8000

Italia

Roche S.p.A.
Tel: +39 - 039 2471

Lietuva

UAB "Roche Lietuva"
Tel: +370 5 2546799

Luxembourg/Luxemburg

(Voir/siehe Belgique/Belgien)

Magyarország

Roche (Magyarország) Kft.
Tel: +36 - 1 279 4500

Malta

(See Ireland)

Nederland

Roche Nederland B.V.
Tel: +31 (0) 348 438050

Norge

Roche Norge AS
Tlf: +47 - 22 78 90 00

Österreich

Roche Austria GmbH
Tel: +43 (0) 1 27739

Polska

Roche Polska Sp.z o.o.
Tel: +48 - 22 345 18 88

Portugal

Roche Farmacêutica Química, Lda
Tel: +351 - 21 425 70 00

România

Roche România S.R.L.
Tel: +40 21 206 47 01

Slovenija

Roche farmacevtska družba d.o.o.
Tel: +386 - 1 360 26 00

Slovenská republika

Roche Slovensko, s.r.o.
Tel: +421 - 2 52638201

Suomi/Finland

Roche Oy
Puh/Tel: +358 (0) 10 554 500

Κύπρος

Γ.Α.Σταμάτης & Σια Λτδ.
Τηλ: +357 - 22 76 62 76

Latvija

Roche Latvija SIA
Tel: +371 – 6 7039831

Sverige

Roche AB
Tel: +46 (0) 8 726 1200

United Kingdom (Northern Ireland)

Roche Products (Ireland) Ltd.
Tel: +44 (0) 1707 366000

This leaflet was last revised in

Detailed information on this medicine is available on the European Medicines Agency web site:

<http://www.ema.europa.eu/>.

MIRCERA pre-filled syringe

Instructions For Use

The following instructions explain how to use the MIRCERA pre-filled syringe to give yourself or another individual an injection.

It is important to read and follow these instructions carefully so that you are able to use the pre-filled syringe correctly and safely.

Do not attempt to administer an injection until you are sure that you understand how to use the pre-filled syringe, if in doubt contact a healthcare professional. Children and adolescents less than 18 years should not self-inject MIRCERA, the administration should be performed by a healthcare professional or trained adult caregiver.

Always follow all directions in these Instructions For Use as they may differ from your experience. These instructions will help prevent incorrect treatments or risks such as needle stick injury or an early activation of the needle safety device, or problems related to the attachment of the needle.

IMPORTANT INFORMATION

- Only use MIRCERA pre-filled syringe if you have been prescribed this medication.
- Read the packaging and ensure you have the dose prescribed by your healthcare professional.
- Do not use MIRCERA if the syringe, the needle, the box or the plastic tray containing the syringe appears to be damaged.
- The needle is fragile, handle it with care.
- Do not touch the activation guards (see Figure A) as this may damage the syringe and make it unusable.
- Do not use the syringe if the contents are cloudy, hazy or contain particles.
- Never attempt to take the syringe apart.
- Never handle or pull on the syringe by its plunger.
- Do not remove the needle shield until you are ready to perform an injection.
- Do not swallow the medicine in the syringe.
- Do not inject through clothing.
- Do not reuse or resterilise the syringe or the needle.
- Pre-filled syringes are not designed for administration of partial doses.
- Keep syringe, needle and supplies out of the reach of children.

STORAGE

Keep the pre-filled syringe, the needle and the puncture-resistant/ sharps container out of the reach of children.

Store the syringe and the needle in its original box until ready to use.

Always store the syringe and the needle in a refrigerator at a temperature of 2 - 8°C (35.6 - 46.4°F).

Do not allow the medicine to freeze, and protect the medicine and the needle from light. Keep the syringe and the needle dry.

MATERIALS INCLUDED IN THE PACK (Figure A):

- A pre-filled syringe containing MIRCERA
- A separate injection needle

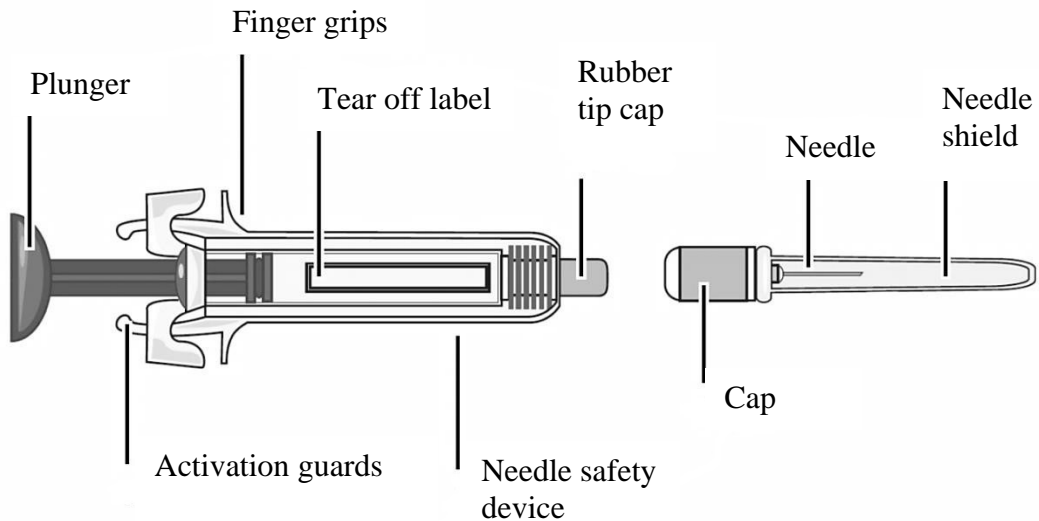

Figure A

|

MATERIALS NOT INCLUDED IN THE PACK (Figure B):

Cleansing
alcohol swabs



Sterile cotton
ball or gauze

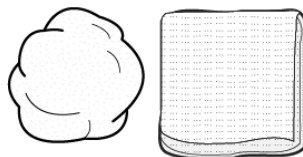

Puncture-resistant container or
sharps container for safe disposal
of needle and used syringe



Figure B

Assemble all of the supplies you will need for an injection on a clean, well-lit flat surface such as a table.

HOW TO GIVE THE INJECTION

Step 1: Allow the syringe to adjust to room temperature

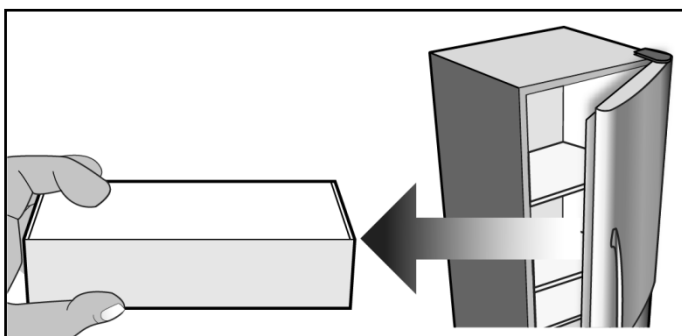

Figure C

Carefully remove the box containing the MIRCERA pre-filled syringe from the refrigerator. Keep the syringe and the needle in the box to protect it from light and allow it to reach room temperature for at least 30 minutes (Figure C).

- Not allowing the medicine to come to room temperature could result in an uncomfortable injection, and it may be difficult to depress the plunger.
- Do not warm up the syringe in any other way.

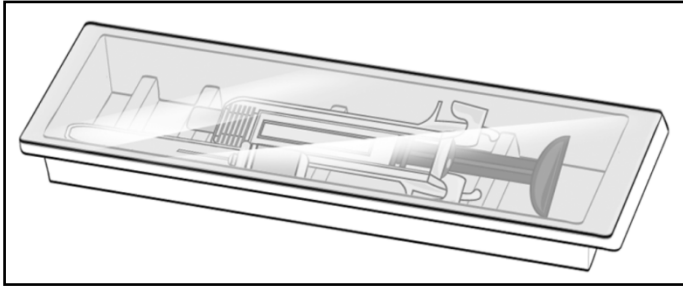

Figure D

Open the box and Remove the plastic tray with the MIRCERA pre-filled syringe without peeling back the protective film (Figure D).

Step 2: Clean your hands



Figure E

Disinfect your hands well with soap and warm water or hands sanitizer (Figure E).

Step 3: Unpack and visually inspect the pre-filled syringe

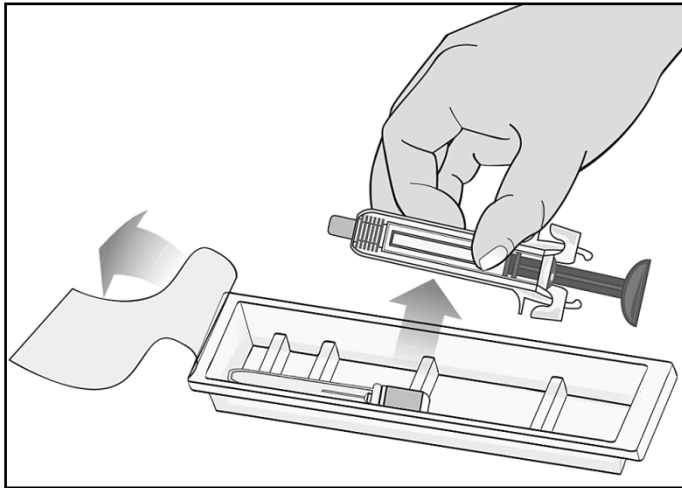

Figure F

Peel back the protective film from the plastic tray and remove the packed needle and the syringe, holding the syringe by the middle of the body without touching the activation guards (Figure F).

Only handle the syringe by the body, because any contact with the activation guards could cause premature release of the safety device.

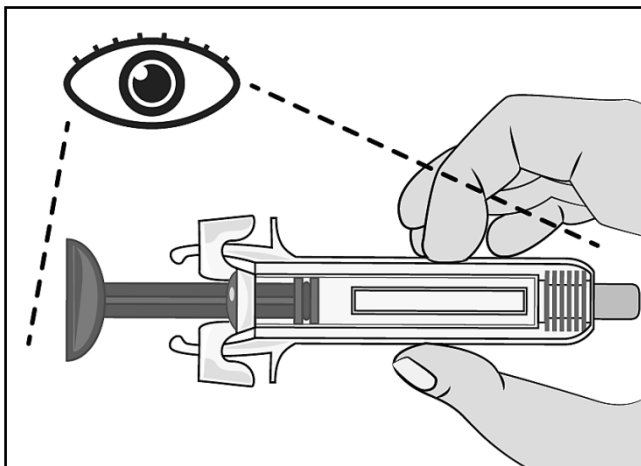

Figure G

Examine the syringe for damage and check the expiration date on the syringe and box. This is important to ensure that the syringe and medicine are safe to use (Figure G).

Do not use the syringe if:

- You have accidentally dropped the syringe.
- Any part of the syringe appears to be damaged.
- The contents are cloudy, hazy or contain particles.
- If the colour is other than colourless to slightly yellowish.
- The expiration date has passed.

Step 4. Attach the needle to the syringe

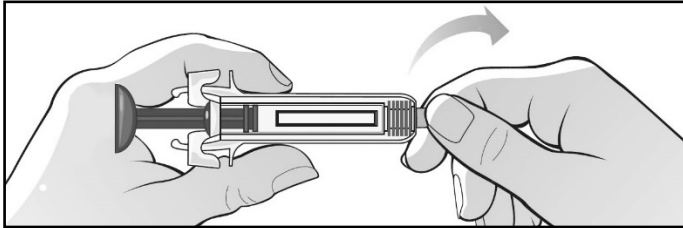

Figure H

Grasp the syringe in the middle of the body, hold the rubber tip cap firmly, and remove the rubber tip cap from the syringe (bend and pull) (Figure H).

- Once removed, immediately dispose of the rubber tip cap in the sharps/ puncture-resistant container.
- Do not touch the activation guards.
- Do not push the plunger.
- Do not pull on the plunger.

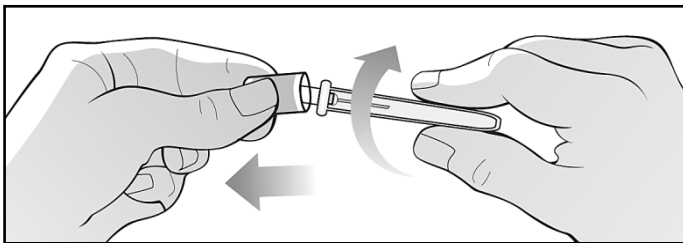

Figure I

Grasp the packaged needle firmly in both hands and examine the packaged needle for damage. Break the seal of the needle, using a twisting motion, and remove the needle cap (Figure I).

Immediately throw away the needle cap in the sharps / puncture-resistant container or sharps container.

Do not remove the needle shield that protects the needle.

Do not use the needle if:

- You have accidentally dropped the needle.
- Any part of the needle appears to be damaged.

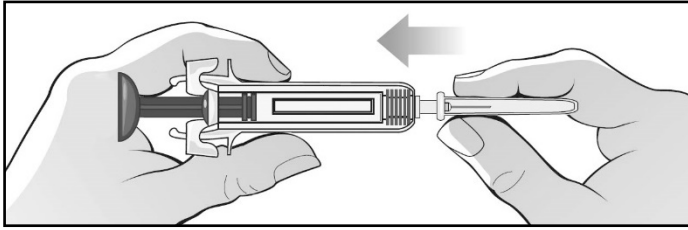

Figure J

Attach the needle to the syringe by pushing it firmly straight onto the syringe and by twisting or turning it slightly (Figure J).

Step 5. Remove the needle shield and prepare for injection

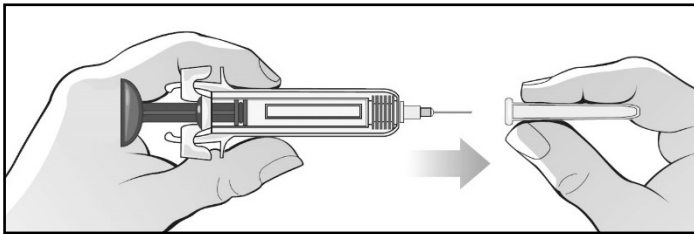

Figure K

Hold the syringe firmly with one hand in the middle of the body and pull the needle shield straight off with the other hand. Throw away the needle shield in the sharps/ puncture-resistant container or sharps container (Figure K).

- Once the needle shield is removed do not touch the needle or let it touch any surface, as the needle may become contaminated and may cause injury and pain if touched.
- You may see a drop of liquid at the end of the needle. This is normal.
- Never reattach the needle shield after removal.

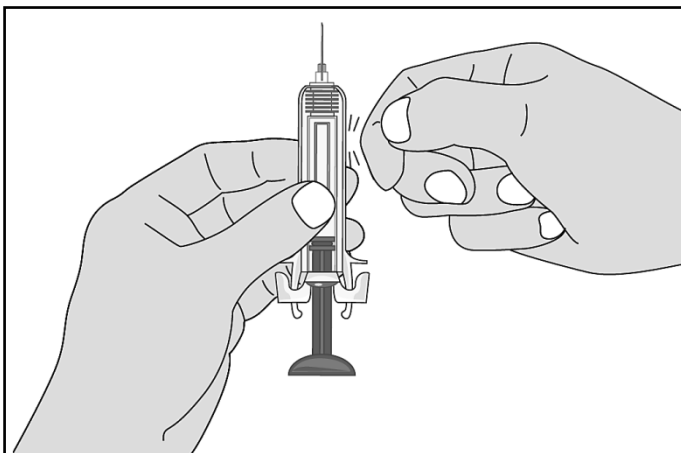

Figure L

To remove air bubbles from the pre-filled syringe, hold the syringe with the needle pointing up. Tap the syringe gently to bring any bubbles to the top (Figure L and M).

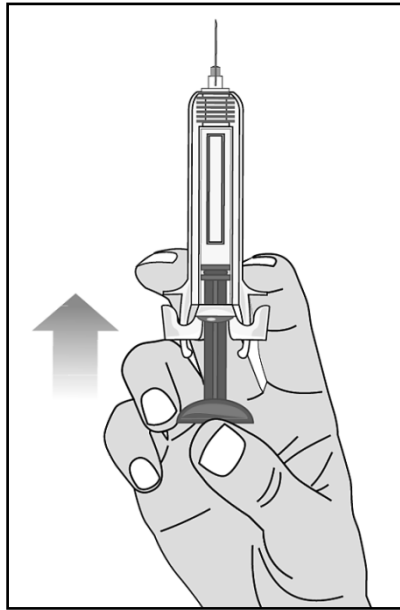

Figure M

Push the plunger up slowly to remove all air, as shown to you by a healthcare professional. (Figure M).

Step 6. Perform the injection

There are two different ways (routes) to inject MIRCERA into your body. Follow the recommendations of your healthcare professional about how you should inject MIRCERA.

SUBCUTANEOUS ROUTE:

If you are advised to inject MIRCERA under your skin, please administer your dose as described below.

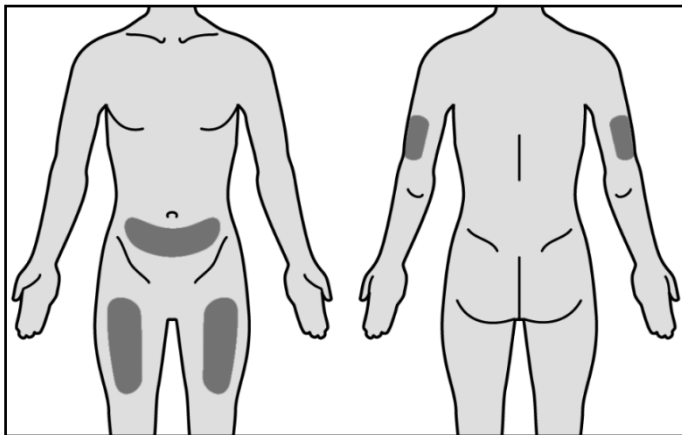

Figure N

Choose one of the recommended injection sites as shown. You may inject MIRCERA into the upper arm, thigh or abdomen, but not in the area around the navel (belly button) (Figure N). The back of the upper arm is not a recommended site for self-injection. Use this injection site only if you inject someone else.

When selecting an injection site:

- You should use a different injection site each time you administer an injection, at least three centimeters from the area you used for the previous injection.

- Do not inject into areas that could be irritated by a belt or waistband.
- Do not inject into moles, scars, bruises, or areas where the skin is tender, red, hard or not intact.

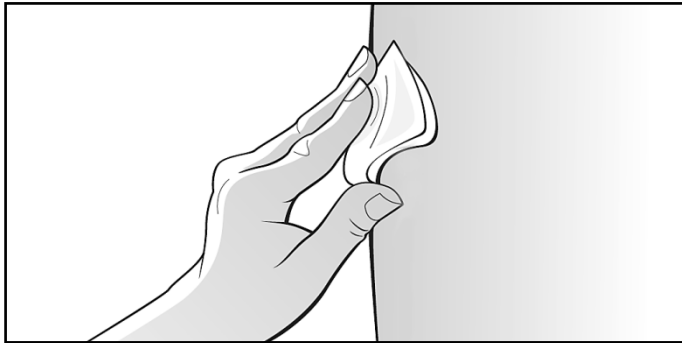

Figure O

Clean the chosen injection site area using an alcohol pad to reduce the risk of infection; carefully follow the instructions of the alcohol pad (Figure O).

- Let the skin dry for approximately 10 seconds.
- Be sure not to touch the cleaned area prior to the injection and do not fan or blow on the clean area.
- Immediately throw away the alcohol pad.

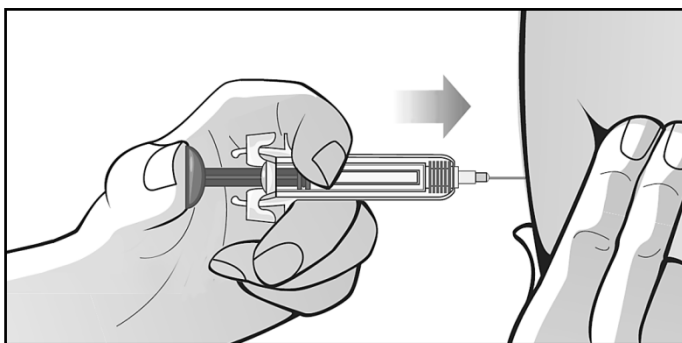

Figure P

Adopt a comfortable posture before performing an injection of MIRCERA.

To be sure the needle can be inserted correctly under the skin, use your free hand to pinch a fold of loose skin at the clean injection site.

Pinching the skin is important to ensure that you inject under the skin (into fatty tissue) but not any deeper (into muscle). Injection into muscle could result in an uncomfortable injection (Figure P).

Carefully fully insert the needle into the skin at an angle of 90° in a quick, "dart-like" motion. Then keep the syringe in position and let go of the pinch of skin.

Do not move the needle while it is inserted in the skin.

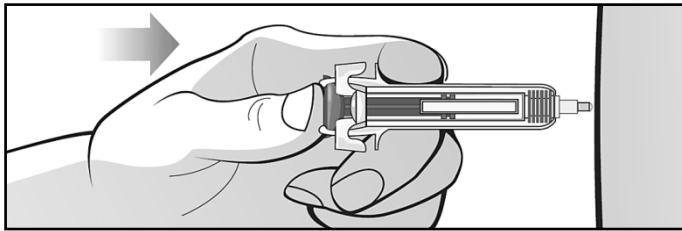

Figure Q

Once the needle is fully inserted into the skin, slowly push the plunger with your thumb while holding the syringe with the forefinger and the middle finger against the finger grips until all the medicine is injected. The plunger rod should be fully pushed down (depressed) and you should hear a click indicating the activation of the needle guard (Figure Q).

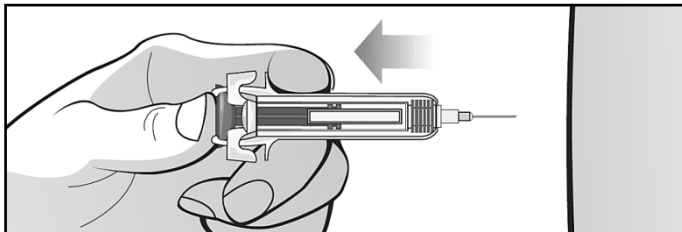

Figure R

Do not release the plunger before the end of injection or before the plunger is completely depressed.

Take the needle out of the skin WITHOUT releasing the plunger (Figure R).

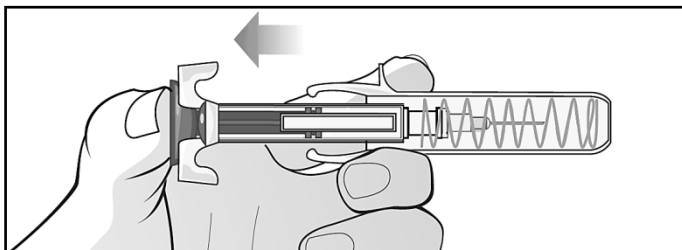

Figure S

Release the plunger, allowing the needle guard to protect the needle (Figure S).

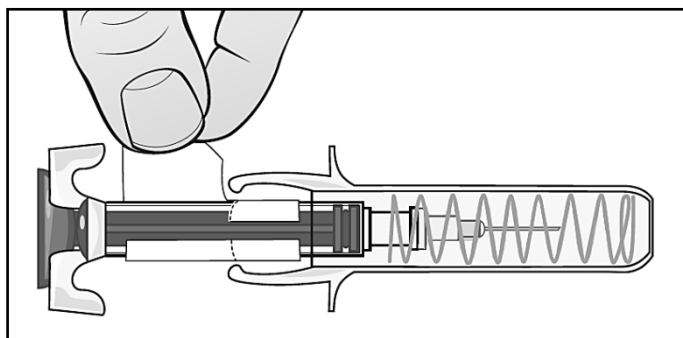

Figure T

Now, the tear-off label can be removed, if necessary (Figure T).

After the injection:

- Place a sterile cotton ball or gauze over the injection site and press for several seconds.
- Immediately throw away the cotton ball or the gauze after use.
- Do not rub the injection site with a dirty hand or cloth.
- If needed, you may cover the injection site with a small bandage.

Dispose of the syringe:

- Do not try to replace the needle shield on the needle.
- Do not reuse or resterilise the syringe and/or the needle.
- Do not throw away the used syringe with the needle via household waste.
- Throw away used syringes in a sharps/ puncture-resistant container and/or according to health institutions policies.
- Dispose of the full sharps/ puncture-resistant container.

INTRAVENOUS ROUTE:

If your healthcare professional has recommended injection of MIRCERA into a vein, you should follow the procedure described below.

After preparation of the syringe as described in steps 1 to 5:

Clean the venous port of the hemodialysis tubing with an alcohol swab as instructed by the provider or manufacturer. Immediately throw away the alcohol swab after use.

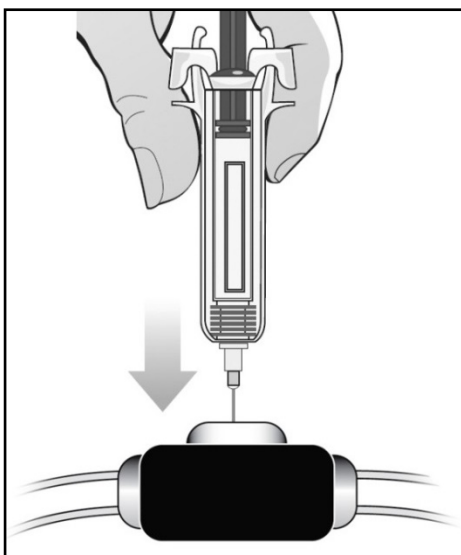

Figure U

Insert the needle of the pre-filled syringe into the cleaned venous port (Figure U).

Do not touch the injection site of the venous port

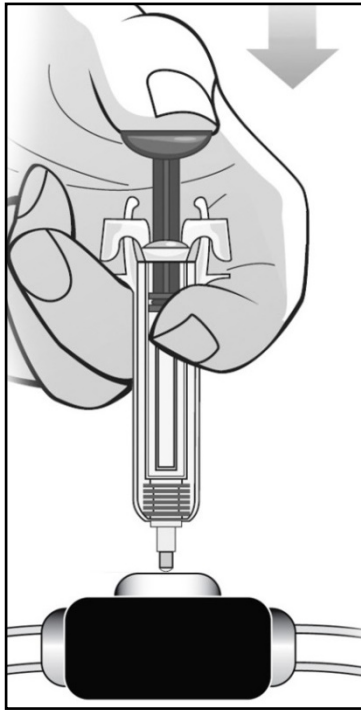

Figure V

Push the plunger with the thumb while holding the syringe with the forefinger and the middle finger against the finger grips until all the medicine is injected (Figure V).

Remove the pre-filled syringe from the venous port **WITHOUT** releasing the plunger.

Once removed release the plunger, allowing the needle guard to protect the needle.

Now, the tear-off label can be removed, if necessary (See Figure T).

Step 7: Dispose of the used syringe with the needle

- Do not try to replace the needle shield on the needle.
- Do not reuse or resterilise the syringe and/or the needle.
- Do not throw away the used syringe with the needle via household waste.
- Throw away used syringes in a sharps/ puncture-resistant container and/or according to health institutions policies.
- Dispose of the full sharps/ puncture-resistant container.